



GOODWE
YOUR SOLAR ENGINE



User Manual

Hybrid Inverter
ES Series

V1.2-2023-01-30

TABLE OF CONTENTS

01 Introduction	1
1.1 Operation Modes Introduction.....	1
1.2 Safety and Warning.....	2
1.3 Product Overview	4
02 Installation Instructions	5
2.1 Unacceptable Installations.....	5
2.2 Packing List	6
2.3 Mounting	6
2.3.1 Select Mounting Location.....	6
2.3.2 Mounting	7
2.4 Electrical Wiring Connection	9
2.4.1 PE Cable Connection	9
2.4.2 PV Wiring Connection	10
2.4.3 Battery Wiring Connection	10
2.4.4 On-Grid&Back-up Connection.....	12
2.4.5 Smart Meter & CT Connections	15
2.5 DRED & Remote Shutdown Device Connection.....	17
2.6 WiFi Module Connection.....	18
2.7 Earth Fault Alarm Connection.....	18
03 MANUAL OPERATION	21
3.1 Wi-Fi Configuration	21
3.2 SolarGo	22
3.3 CEI Auto-Test Function	23
3.4 Startup/shutdown Procedure	23
3.5 SEMS Portal	23

04 OTHER.....	24
4.1 Error Messages.....	24
4.2 Troubleshooting	26
4.3 Disclaimer	30
4.4 Technical Parameters	32
4.5 Quick Checklist To Avoid Dangerous Conditions.....	36
Appendix	37

01 Introduction

The ES series, also called hybrid or bidirectional solar inverters, apply to solar system with participation of PV, battery, loads and grid system for energy management. The energy produced by PV system shall be used to optimize household, excess power charges battery and the rest power could be exported to the grid. Testing to AS/NZS 4777.2:2020 for multiple phase combinations has not been conducted

The battery shall discharge to support loads when PV power is insufficient to meet self-consumption needs. If battery power is not sufficient, the system will take power from the utility grid to support loads.

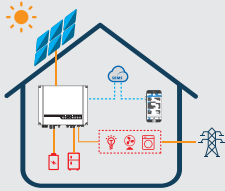

The preceding introduction describes the general operation of the ES system. The operation mode can be changed with the SolarGo app based on the system layout. The possible operation modes for the ES system are shown below.

1.1 Operation Modes Introduction

ES system normally has the following operation modes based on your configuration and layout conditions.

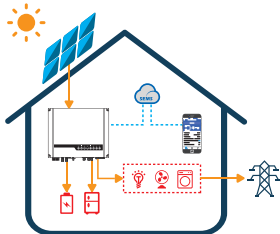

Mode I

The energy produced by the PV system is used to optimize self-consumption needs. The excess energy is used to recharge the batteries, any remaining excess is then exported to the grid.

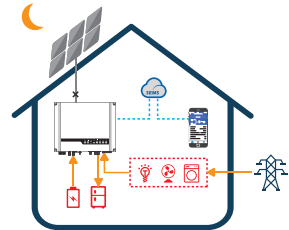

Mode II

When there is no PV, and the battery is sufficient, it can supply the load together with grid power.

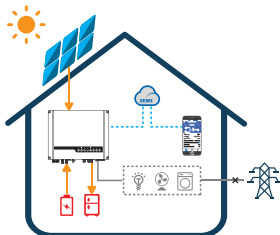

Mode III

When the grid fails, the system will automatically switch to back-up mode. The back-up loads can be supplied by both PV and battery energy.

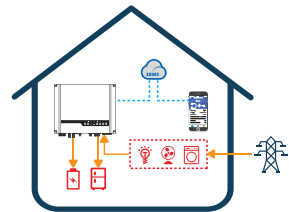

Mode IV

Battery could be charged by grid, and charge time/power could be set to various options on the SolarGo App.

1.2 Safety and Warning

The ES series of inverters from GoodWe Technologies Co., Ltd. (also called GoodWe) strictly complies with related safety rules for product design and testing. Please read and follow all of the instructions and cautions appearing on the inverter or in the User Manual during installation, operation and maintenance, as any improper operation might cause personal injury or property damage.

Symbol Explanation



Caution!
Failure to observe any warnings contained in this manual may result in injury.



Danger - high voltage and electric shock!



Danger - hot surface!



The components of the product can be recycled.



This side up! This package must always be transported, handled and stored in such a way that the arrows always point upwards.



No more than six (6) identical packages being stacked on each other.



Products shall not be disposed as household waste.



Fragile - The package/product should be handled carefully and never be tipped over or slung.



Refer to the operating instructions.



Keep dry! The package/product must be protected from excessive humidity and must be stored under cover.



This symbol indicates that you should wait at least 5mins after disconnecting the inverter from the utility grid and from the PV panel before touching any inner live parts.



CE mark.

Safety Warnings

Any installation or operations on the inverter must be performed by qualified electricians in compliance with standards, wiring rules and the requirements of local grid authorities or companies (such as AS 4777 and AS/NZS 3000 in Australia).

Before any wiring connection or electrical operation on inverter, all battery and AC power must be disconnected from inverter for at least 5 minutes to make sure inverter is totally isolated to avoid electric shock.

The temperature of inverter surface might exceed 60°C during operation, so please make sure it has cooled down before touching it, and make sure the inverter is out of reach of children.

Do not open the inverter's cover or change any components without manufacturer's authorization, otherwise the warranty commitment for the inverter will be invalid.

Usage and operation of the inverter must follow instructions in this user manual, otherwise the protection design might be impaired and warranty commitment for the inverter will be invalid.

Appropriate methods must be adopted to protect inverter from static damage. Any damage caused by static is not warranted by manufacturer.

PV negative (PV-) and battery negative (BAT-) on inverter side is not grounded as default design. Connecting PV- to EARTH are strictly forbidden.

PV modules used on the inverter must have an IEC61730 class A rating, and the total open-circuit voltage of PV string/array is lower than the maximum rated DC input voltage of the inverter. Any damage caused by PV over-voltage is beyond warranty.

The inverter, with built-in RCMU, will exclude possibility of DC residual current to 6mA, thus in the system an external RCD (type A) can be used($\geq 30\text{mA}$).

In Australia, the inverter internal switching does not maintain neutral integrity, which must be addressed by external connection arrangements like in the system connection diagram for Australia.

In Australia, output of back-up side in switchbox should be labeled on "Main Switch UPS Supply".The output of normal load side in switch box should be labeled "Main Switch Inverter Supply".



1.3 Product Overview

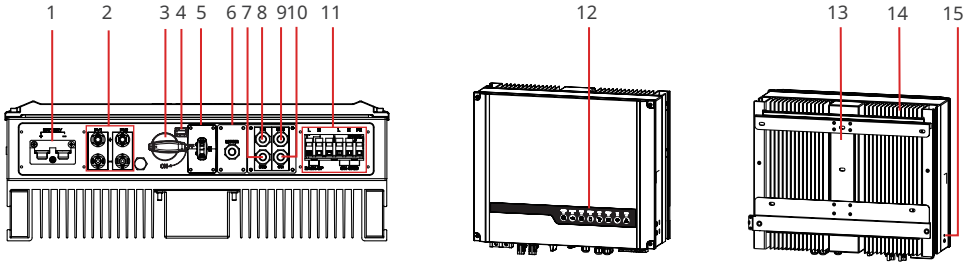

- | | | |
|---|--|-----------------------------|
| 1. Battery Terminal (BATTERY +/-) | 2. PV Input Terminal (PV1/ PV2) | 3. DC Switch (optional)* |
| 4. DC Switch Locking Hole | 5. Communication Module Port (WiFi or LAN) | 6. METER Communication Port |
| 7. DRED or Remote Shutdown Communication Port | 8. BMS Communication Port | 9. RS485 Communication Port |
| 10. Reserved Port | 11. AC Terminal (ON-GRID and BACKUP) | 12. Indicators |
| 13. Mounting Plate | 14. Heat Sink | 15. PE Terminal |

* Model GW3648D-ES inverters are designed without DC switch. For inverters designed with DC switch, the model name should be GW3648C-ES.
 Model GW5048D-ES inverters are designed without DC switch. For inverters designed with DC switch, the model name should be GW5048C-ES.
 If the inverter is not equipped with a DC switch, an external DC breaker shall be added. The external DC breaker shall be AU/NZ certified; Complied to AS60947.3:2018; Be classified as DC-PV 2; With ratings and properties suitable for the intended application conditions such as outdoor, exposed to sunshine, on non-combustible material surface.

LED Indicators

INDICATOR	COLOR	STATUS	EXPLANATION
SYSTEM	Green		ON = System is ready
			BLINK = System is starting up
			OFF = System is not operating
BACK-UP	Green		ON = Back-up is ready / power available
			OFF = Back-up is off / on power available
BATTERY	Blue		ON = Battery is charging
			BLINK 1 = Battery is discharging
			BLINK 2 = Battery is low / soc is low
			OFF = Battery is disconnected / not active
GRID	Blue		ON = Grid is active and connected
			BLINK = Grid is active but not connected
			OFF = Grid is not active
ENERGY	Yellow		ON = Consuming energy from grid / buying
			BLINK 1 = Supplying energy to grid / zeroing
			BLINK 2 = Supplying energy to grid / selling
			OFF = Grid not connected or system not operating
SOLAR	Blue		ON = Solar inputs #1 and #2 are active
			BLINK 1 = Solar input #1 is active / #2 is not active
			BLINK 2 = Solar input #2 is active / #1 is not active
			OFF = Solar input #1 and #2 are not active
WIFI	Yellow		ON = WiFi connected / active
			BLINK 1 = WiFi system resetting
			BLINK 2 = WiFi not connect to router
			BLINK 4 = WiFi server problem
			OFF = WiFi not active
FAULT	Red		ON = Fault has occurred
			BLINK = Overload of back-up / Output / reduce load
			OFF = No fault

02 Installation Instructions

2.1 Unacceptable Installations

Please avoid the following installations which will damage the system or the Inverter. The following installations should be avoided. Any damage caused will not be covered by the warranty policy.

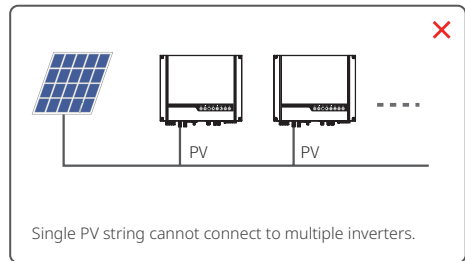
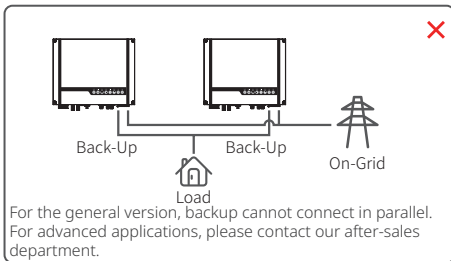

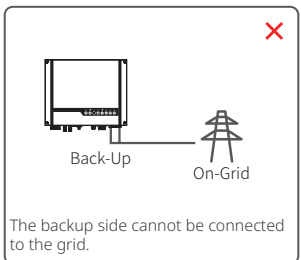
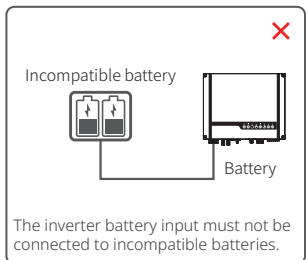
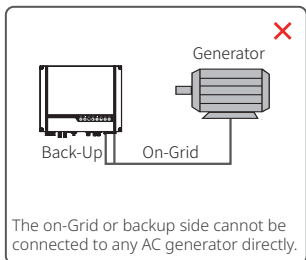
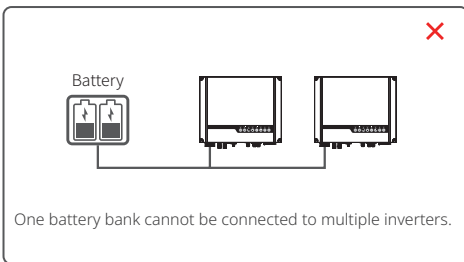
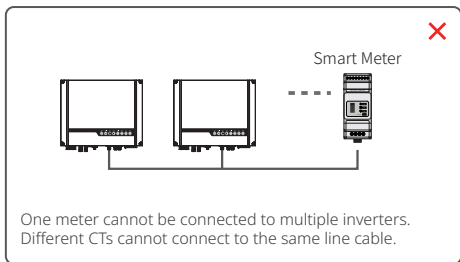

2.2 Packing List

Upon receiving the hybrid inverter, please check if any of the components as shown below are missing or broken.

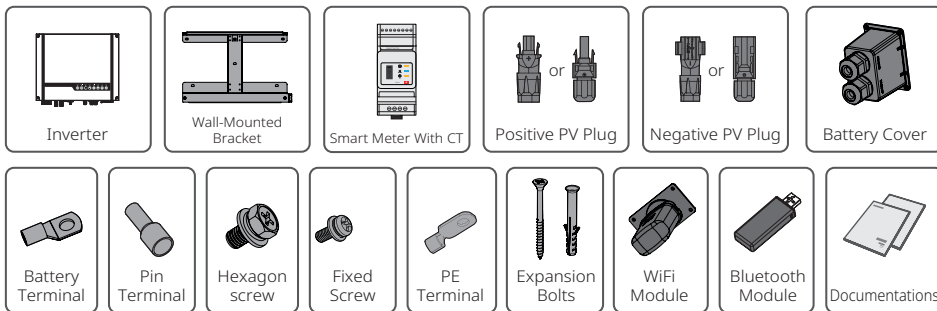

2.3 Mounting

2.3.1 Select Mounting Location

Mounting Support Requirements

- The mounting support shall be nonflammable and fireproof.
- Make sure that the support surface is solid enough to bear the product weight load.
- Do not install the product on the support with poor sound insulation to avoid the noise generated by the working product, which may annoy the residents nearby.

For inverter's protection and convenient maintenance, mounting location for inverter should be selected carefully based on the following rules:

Rule 1. Any part of this system shouldn't block the switch and breaker from disconnecting the inverter from DC and AC power.

Rule 2. Inverter should be installed on a solid surface, where it is suitable for inverter's dimensions and weight.

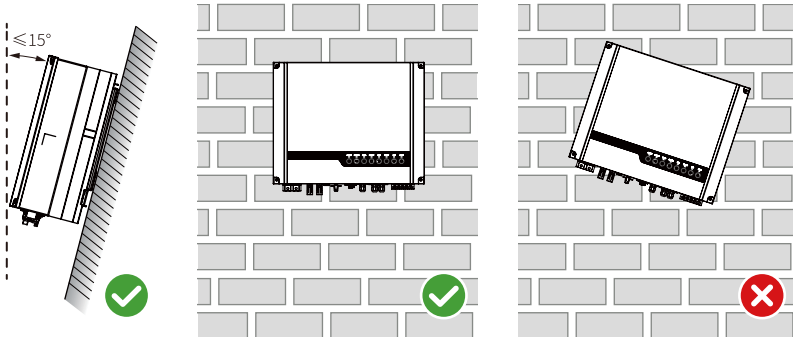

Rule 3. Inverter should be installed vertically with a max rearward tilt of 15°.

Rule 4. Ambient temperature should be lower than 45°C. The temperature and humidity at the installation site should be within the appropriate range (60 °C for outdoor unconditioned with solar effects).

Rule 5. It is recommended that the installation of the inverter should be prevented from direct sunlight, snow, rain and other negative influences which may cause function impact or life aging.

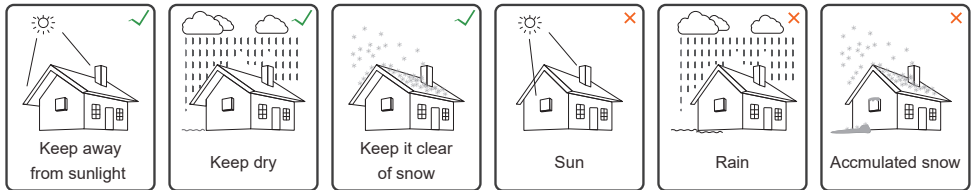

Rule 6. Inverter should be installed at eye level for convenient maintenance.

Rule 7. Product label on inverter should be clearly visible after installation. Do not damage the label.

Rule 8. Do not install the inverter when it is snowing or raining. If you have to, pay attention to the waterproof and moisture-proof of the inverter and distribution box.

Rule 9. Leave enough space around the inverter according to the below figure for natural heat dissipation.

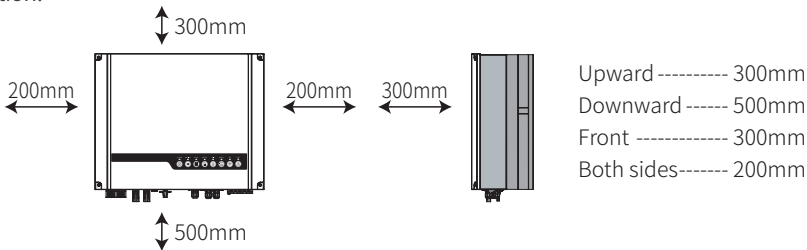

If there is any radio or wireless communication equipment below 30mhz near the inverter, make sure that:

1. Install the inverter at least 30m far away from the high-precision wireless equipment.
2. Add ferrite core with multi coil winding or low pass EMI filter to the DC cable or AC cable.

2.3.2 Mounting



Remember that this inverter is heavy! Please be careful when lifting out from the package.



The inverter is suitable for mounting on concrete or other non-combustible surfaces only.

- 1 Please use the mounting bracket as a template to drill 4 holes in the correct positions (10mm in diameter and 80mm in depth). Use the expansion bolts in the accessory box and tightly attach the mounting bracket to the wall.

Note: Bearing capacity of the wall must be higher than 25kg, otherwise it may not be able to keep the inverter from dropping.

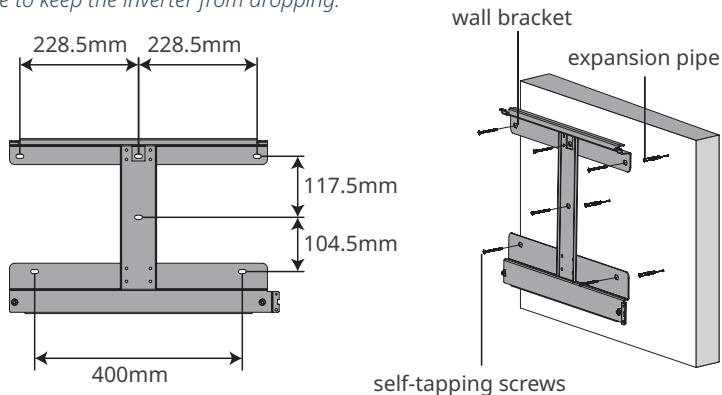

- 2 FOR AUSTRALIA ONLY. Lock the DC switch before mounting. Unlock the DC switch when you are going to switch it to power on or power off the inverter.

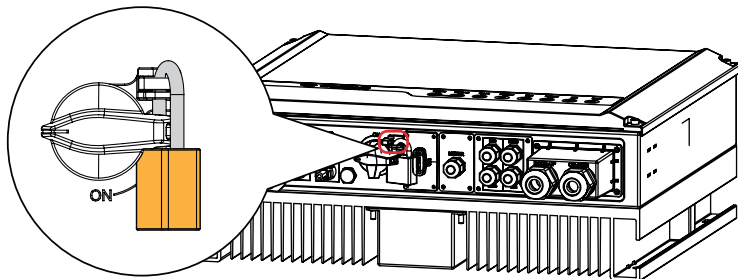

- 3 Carry the inverter by holding the heat sink on two sides and place the inverter on the mounting bracket.

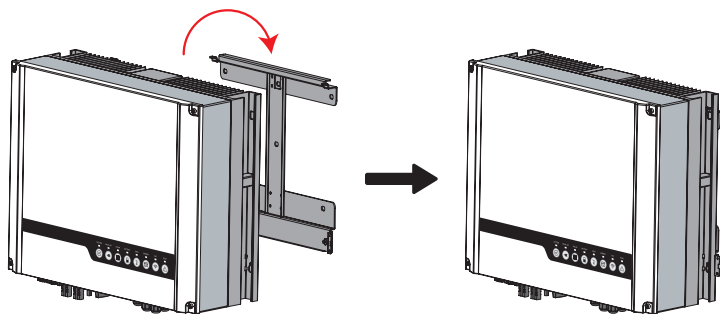

- 4 The inverters can be locked for anti-theft purposes if this is necessary for individual requirements.

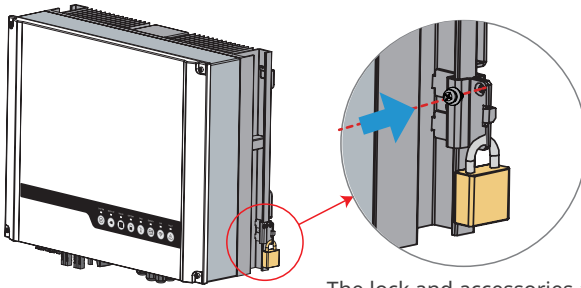

The lock and accessories are not included in the package and can be purchased by the user.

2.4 Electrical Wiring Connection

2.4.1 PE Cable Connection

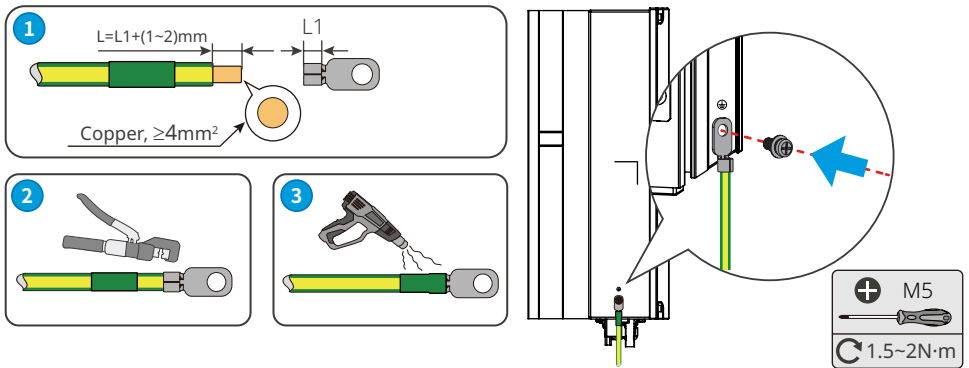

- Disconnect the PE cable after dismantling the equipment if needed.
- To improve the corrosion resistance of the terminal, it is recommended to apply silica gel or paint on the ground terminal after installing the PE cable.
- The PE cable should be prepared by customers. Recommended specifications:
 - Type: single-core outdoor copper cable.
 - Conductor cross-sectional area $S \geq 4\text{mm}^2$.



2.4.2 PV Wiring Connection

Before connecting PV panels/strings to the inverter, please make sure all requirements listed below are followed:

- The total short-circuit current of a PV string must not exceed the inverter's max DC current.
- The minimum impedance to earth of the PV module shall be greater than R . $R = \text{Max.Input Voltage (V)} / 30\text{mA}$, i.e. $R = 1100\text{V} / 30\text{mA} = 36.7\text{k}\Omega$ or $R = 1000\text{V} / 30\text{mA} = 33.4\text{k}\Omega$.
- The PV string must not be connected to the earth/grounding conductor.
- Use the right PV plugs in the accessory box. (BAT plugs are similar to PV plugs. Please check before using them.)

Note: There are MC4, QC4.10, or Amphenol plugs in the accessory box. The connection details are shown below.

1 Prepare the PV cables and PV plugs.

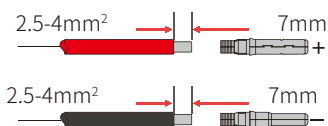

Note:

1. Please use the PV plugs and connectors from the accessory box.
2. The PV cable should be a standard 2.5-4mm².

2 Connect the PV cable to the PV connectors.

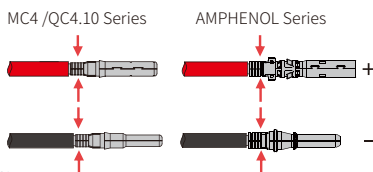

Note:

1. Crimp the PV cable tightly onto the connectors.
2. For Amphenol connectors, the limit buckle cannot be pressed.
3. There will be a clicking sound if the connectors are inserted correctly into the PV plugs.

3 Screw the cap on and plug it into the inverter side.

Note: There will be a clicking sound if the connectors are inserted correctly into the PV plugs.

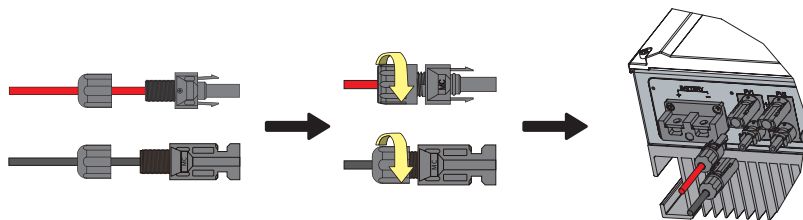

The polarity of the PV strings must not be connected in a reverse manner. Otherwise, the inverter could be damaged.

2.4.3 Battery Wiring Connection

Please be careful of any electric shock or chemical hazards.

Make sure there is an external DC breaker ($\geq 125\text{A}$) connected to the battery without build-in DC breaker.



Make sure that the breaker is off and battery nominal voltage meets ES series' specification before connecting battery to inverter. Make sure inverter is totally isolated from PV and AC power.

For lithium battery (pack) the capacity should be 50Ah or larger. Battery cable requirements are as following.

You are recommended to refer to the battery user manual as well when selecting the battery cable.

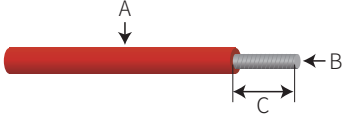

Grade	Description	Value
A	Outside diameter Insulation	10-14mm
B	Insulation section	NA
C	Conductor core length	20-35mm ²

Battery wiring connection process

- 1 Prepare battery cables and accessories and put battery power cable through battery cover.

Note:

1. Please use accessories from accessory box.
2. Battery power cable should be 20-35mm².

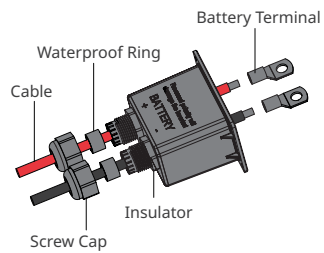

- 2 Make battery terminals
 - Strip cable coat, revealing 10mm length of metal core.
 - Use special crimper to compress battery terminal tightly.

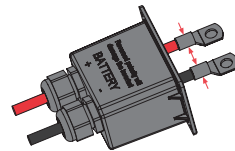

- 3 Connect battery terminal onto inverter.

Note:

Please make sure polarity (+/-) of battery are not reversed.

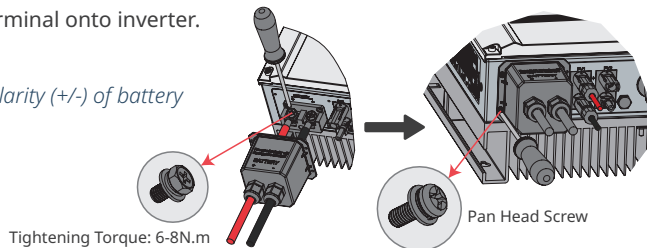

* For the compatible lithium batteries (LG / PYLON / BYD / GCL / DYNESS / ALPHA) connection, please refer to <https://en.goodwe.com>.

Battery Protection

Battery will act as a protective charge/discharge current limitation under any condition as below:

- Battery SOC is lower than I-DOD (Depth of discharge).



- Battery voltage is lower than discharge voltage.
- Battery over heating protection.
- Battery communication is abnormal for lithium battery.
- BMS limitation for lithium battery.

When charge/discharge current limitation protection happens:

- Under on-grid mode, battery charge/discharge operation could be abnormal.
- Under off-grid mode, Back-Up supply will shut down.

Note:

- Under off-grid mode, if Back-Up supply shuts off because of battery, low battery SOC or voltage, PV power will all be used to charge battery till battery SOC reaches $40\% + (1-DOD)/2$, then Back-Up supply will be activated.
- Under on-grid mode & off-grid mode, battery is protected from over discharge by DOD and discharge voltage.
- The DOD setting of a battery prevents the inverter from discharging battery reserve power. As soon as the DOD is reached the load of building will only be supported by either PV power or the grid. If there are continuous days when little or no battery charging occurs, the battery may continue to self-consume energy to support communications with the inverter. This behavior is different between battery manufactures products, however, if the SOC of the battery reaches a certain level, the inverter will boost the SOC back up. This protection mechanism safeguards the battery from falling to 0% SOC.

2.4.4 On-Grid&Back-up Connection

An external AC breaker is needed for on-grid connection to isolate the inverter from the utility grid when necessary.

The requirements for the on-grid AC breaker are shown below.

Inverter Model	AC Breaker Specification
GW3648D-ES	32A / 230V (e.g. DZ47-60 C32)
GW5048D-ES	40A / 230V (e.g. DZ47-60 C40)

Note: The absence of AC breaker will lead to inverter damage if an electrical short circuit happens on grid side.

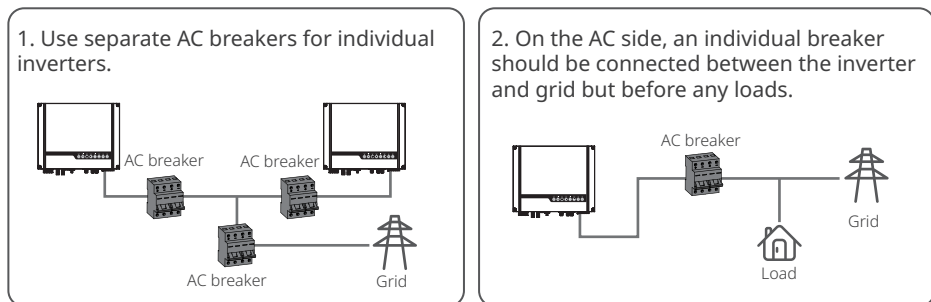

Requirement of AC cable connected to On-Grid and Back-Up side.



Make sure the inverter is totally isolated from any DC or AC power before connecting the AC cable.

Note:

1. Neutral cable shall be blue, line cable shall be black or brown (preferred) and protective earth cable shall be yellow-green.
2. For AC cables, PE cable shall be longer than N&L cables, so in case that the AC cable slips or is taken out, the protecting earth conductor will be the last to take the strain.

1 Prepare the terminals and AC cables according to the correct table.

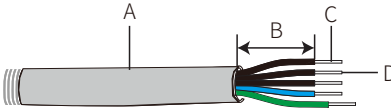

Grade	Description	Value
A	Outside diameter	13-18 mm
B	Separated wire length	20-25 mm
C	Conductor wire length	7-9 mm
D	Conductor core section	4-6 mm ²

2 Put AC cable through terminal cover as shown in the figure.

Note: Please use the terminals in accessory box.

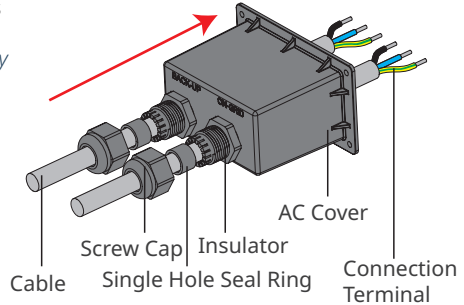

3 Press the 6 connectors on cable conductor core tightly.

Note: Make sure cable jacket is not locked within the connector.

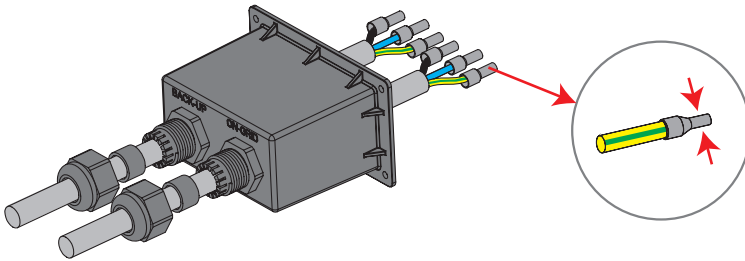

4

Tightening torque
2.0-2.5N·m

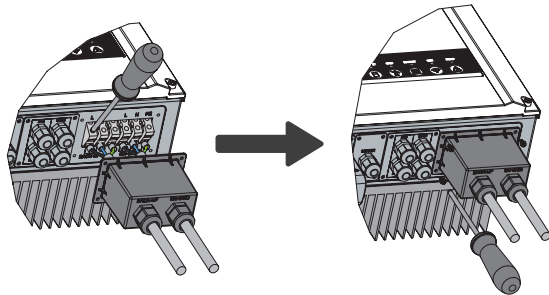

1. Connect the assembled AC cables into AC terminals with fastening torque about 2.0-2.5N·m.

Note: Connect back-up terminals before connecting on-grid terminals. Make sure it is not connected to a wrong side.

2. Lock the cover and screw the cap.



Special adjustable settings

The inverter has a field where the user could set functions, such as trip points, trip time, time of reconnection, active and invalid of QU curve and PU curve etc. by special firmware. Please contact after-sales for the special firmware and adjustable methods.

Connection For SPLIT Grid System

In SPLIT grid system, there is a solution to allow inverter to work under on-grid condition. For details, please check the official application plan on website -GoodWe Hybrid Solution For Split Grid Type.

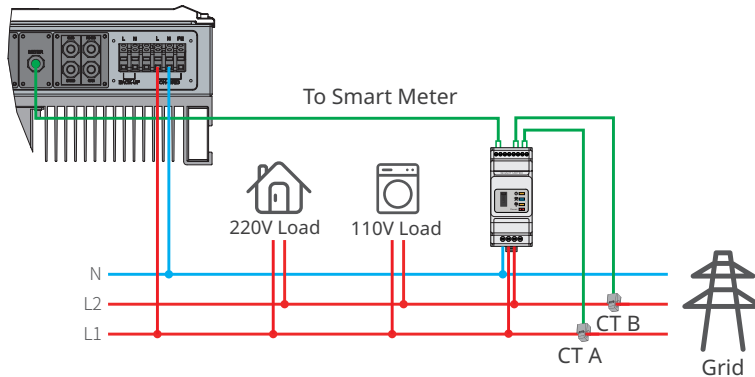

Declarations For The Backup Function

The back-up output of ES hybrid inverters have over load ability.

For details please refer to the technical parameters of ES series inverter section (Page 31).

And the inverter has self-protection derating at high ambient temperature.

The below statement lays out general policies governing the energy storage inverters of the series EH, EM, ES, ET, BH, BT and SBP.

1. For Hybrid inverters (Series EH, EM, ES and ET), the standard PV installation typically consists of the connection of the inverter with both panels and batteries. In the case where the system is not connected to the batteries, the back-up function is strongly not advised for use. Manufacturer shall not cover the standard warranty and be liable for any consequences arising from users not following this instruction.

2. Under normal circumstances, the back-up switching time is less than 10 ms (the minimal condition to be considered as the UPS level). However, some external factors may cause the system failing on back-up mode. As such, we recommend the users to be aware of conditions and follow the instructions as below:

- Do not connect loads when they are dependent on a stable energy supply for a reliable operation.
- Do not connect the loads which may in total exceed the maximum back-up capacity.
- Try to avoid those loads which may create very high start-up current surges such as inverter air-conditioner, high-power pump etc.
- Due to the condition of the battery itself, battery current might be limited by some factors including but not limited to the temperature, weather etc.

Acceptable Loads Are As Below:

ES series inverter is able to supply a continuous 4600VA output or maintain a 6900VA output for less than 10 seconds on back-up side to support loads. The inverter also has self-protection against derating at high ambient temperature.

- Inductive Load: Maximum 1.5KVA for single inductive load, maximum 2.5KVA for total inductive load power.
- Capacitive Load: Total capacitive load (like computer, switch power etc.) power ≤ 3.0 KVA. (Any load with high inrush current at start-up is not accepted)

Note:

For convenient maintenance, please install a SP3T switch on back-up and on-grid side. Then it is adjustable to support load by back-up or by grid or default settings.

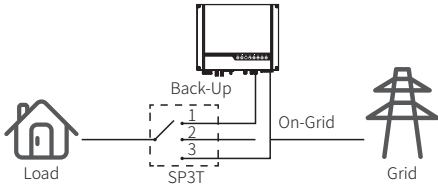

1. Back-up load is supplied from back-up side.
2. Back-up load is isolated.
3. Back-up load is supplied from grid side.

Declarations For Backup Overload Protection

Inverter will restart itself if overload protection triggers. The preparation time for restarting will be longer and longer (one hour at most) if overload protection repeats. Take following steps to restart inverter immediately.

Decrease back-up load power within maximum limitation.

On The SolarGo App > Advanced Settings > Click "Reset Backup Overload History".

2.4.5 Smart Meter & CT Connections

 Make sure the AC cable is totally isolated from AC power before connecting the Smart Meter and CT.

A Smart Meter with the CT in product box is compulsory for ES system installation. It can be used to detect the grid voltages and current directions, provide the operating condition of the ES inverter via RS485 communications. For more detailed information of the Smart Meter, refer to the Smart Meter user manual in <https://en.goodwe.com>.

Note:

1. The Smart Meter with CT is already configured ; please do not change any settings on the Smart Meter.
2. One Smart Meter can be used with only one ES inverter.
3. Three CTs must be used for one Smart Meter and must be connected on the same phase with the Smart Meter power cable.

Smart Meter & CT connection diagram

• For Single Phase Grid

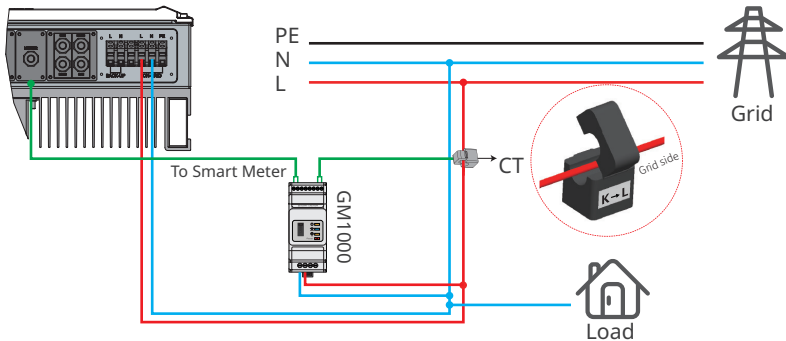

• For Three Phase Grid

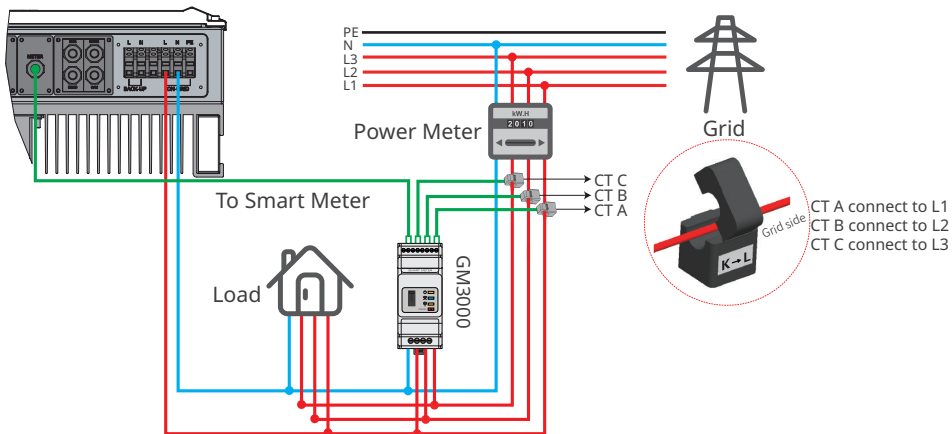

Note:

1. Please use the Smart Meter with 3 CTs in product box.
2. CT cable is 3m as default, could be extended to maximum of 5m.
3. Smart Meter communication cable (RJ45) is attached on the inverter ("To Smart Meter" cable), could be extended to max 100m, and must use standard RJ45 cable and plug, as below:

Detailed PIN Functions Of Each Port On The Inverter

BMS: CAN communication is configured by default. If 485 communication is used, please contact the after-sales service to replace this with the correct communication cable.

Position	Color	BMS Function	Smart Meter Function	EMS
1	Orange & white	485_A2	NC	485_A
2	Orange	NC	NC	485_B
3	Green & white	485_B2	485_B1	485_A
4	Blue	CAN_H	NC	NC
5	Blue & white	CAN_L	NC	NC
6	Green	NC	485_A1	485_B
7	Brown & white	NC	485_B1	NC
8	Brown	NC	485_A1	NC

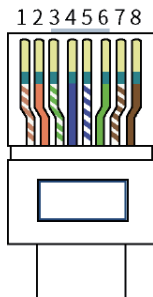

Smart Meter LED Indications

STATUS	OFF	ON	Blinking
POWER	Not working	Working	/
ENERGY	/	Importing	Exporting
COM	Single blink when data are transferred to the inverter		

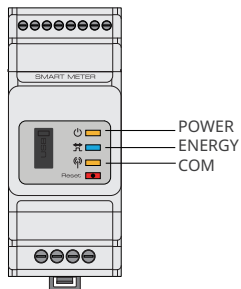

2.5 DRED & Remote Shutdown Device Connection

DRED (Demand response enabling device) is used for Australia and New Zealand installation (also used as remote shutdown function in European countries), in compliance with Australia and New Zealand safety requirements (or European countries). Inverter integrates control logic and provides an interface for DRED. The DRED is not provided by inverter manufacturer. Detailed connection of DRED & Remote Shutdown are shown below.

- 1 Screw this plate off from the inverter.

Note: DRED should be connected through "DRED Port" as the figure shows.

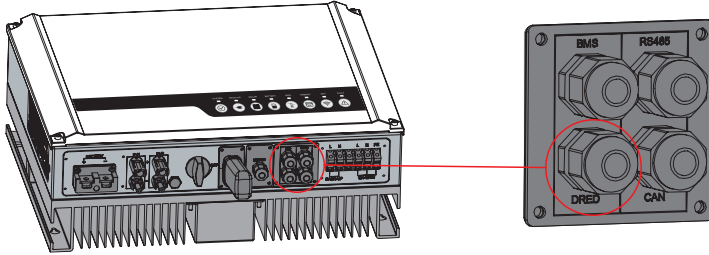

- 2

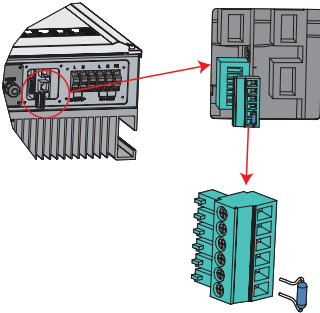

1. Plug out the 6-pin terminal and dismantle the resistor on it.
2. Plug the resistor out, leave the 6-pin terminal for next step.

Note: The 6-pin terminal in the inverter has the same function as DRED. Please leave it in the inverter if no external device is connected.

3-1 For DRED

1. Put DRED cable through the plate.
2. Connect DRED cable on the 6-pin terminal.

The function of each connection position as below.

NO	1	2	3	4	5	6
Function	DRM1/5	DRM2/6	DRM3/7	DRM4/8	REFGEN	COM /DRMO

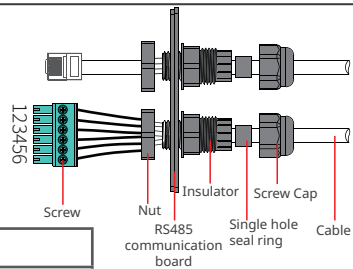



3-2 For Remote Shutdown

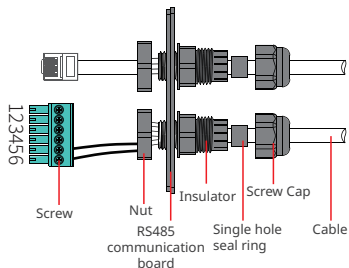

1. Put the cable through the plate.
 2. Connect cable on the 6-pin terminal.(Wiring from the No. 5 and 6 holes respectively.)
- The function of each connection position as below.

NO	5	6
Function	REFGEN	COM /DRMO

4 Connect DRED terminal to the right position onto the inverter.

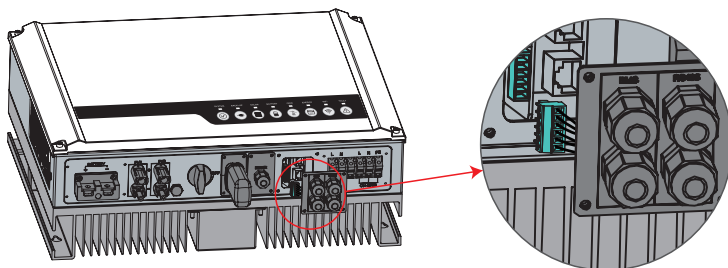

2.6 WiFi Module Connection

The Wi-Fi communication function is only applied to WiFi Module.

Insert the 5-Pin terminal to WiFi module.

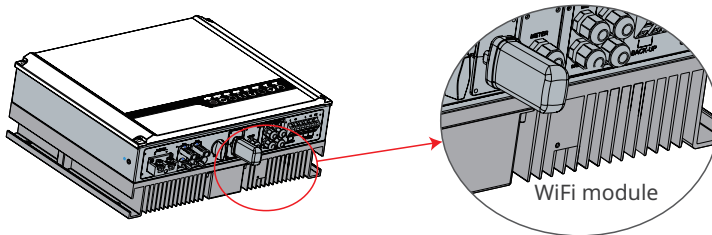

2.7 Earth Fault Alarm Connection

The inverter complies with IEC 62109-2 13.9. Fault indicator LED on inverter cover will light up and the system will email the fault information to customer. It must be installed in a high traffic area where the LED would be noticed.

Inverter should be installed at eye level for convenient maintenance.

Wiring System For The Hybrid Inverter

Note: This diagram indicates the wiring structure of the hybrid inverter, not the electric wiring standard.

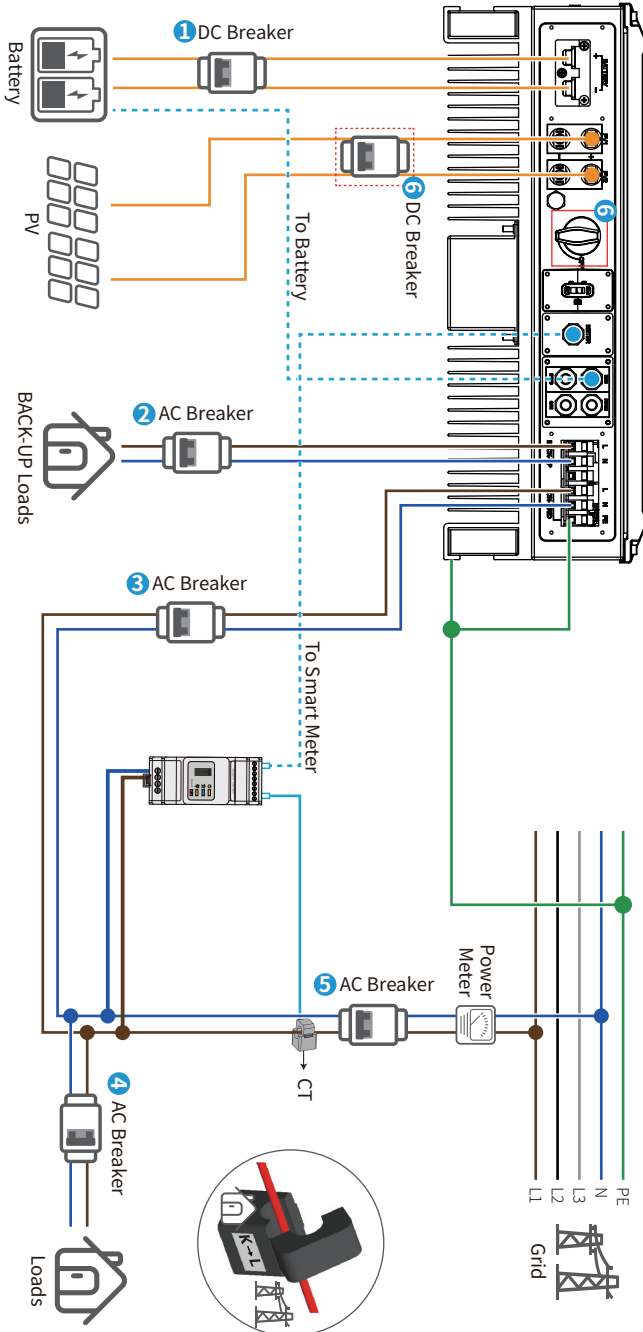

Please select the breaker according to the specifications below:

Inverter	(1)	(2)	(3)	(4)(5)	(6)
GW3648D-ES	125A/60V DC Breaker	25A/230V AC breaker	16A/230V AC breaker	Depends on household loads	30A/600V DC Breaker
GW5048D-ES		32A/230V AC breaker	20A/230V AC breaker		

1. For batteries with attached breaker, the external DC breaker could be omitted.
2. Only for lithium battery which has BMS communication.
3. Direction of the CT cannot be connected in reverse, please follow "House→Grid" direction to do the connection.



System Connection Diagrams

Note: According to Australian safety requirements, the neutral cables of the on-grid side and backup side must be connected together. Otherwise, the backup function will not work.

This diagram is an example for an application that neutral connects with the PE in a distribution box.

For countries such as Australia, New Zealand, South Africa, etc., please follow local wiring regulations!

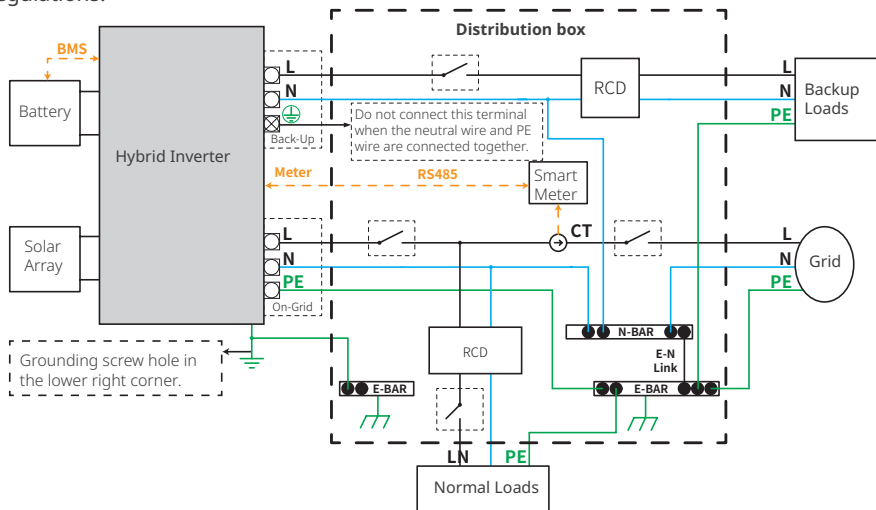

This diagram is an example for grid systems without special requirements on electrical wiring connection.

NOTE: The back-up PE line and earthing bar must be grounded properly and effectively. Otherwise the back-up function may be abnormal when the grid fails.

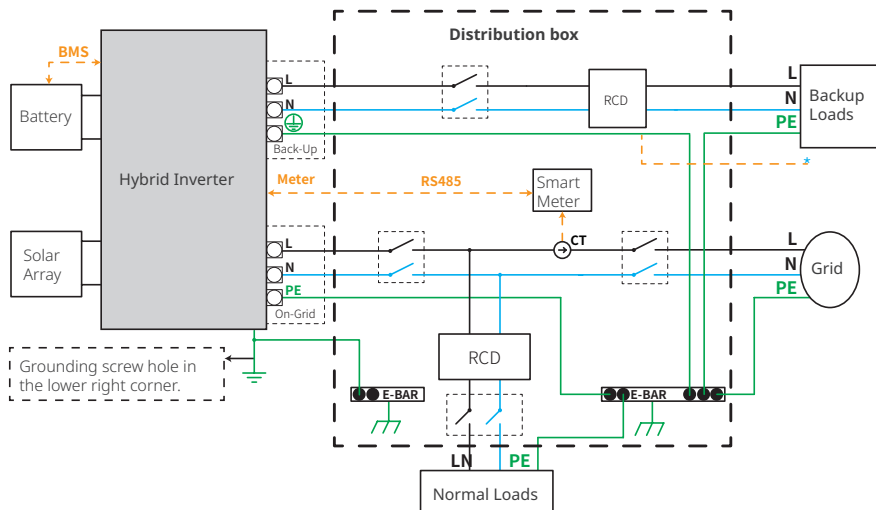

03 MANUAL OPERATION

3.1 Wi-Fi Configuration

This part shows the configuration using a web page. Wi-Fi configuration is absolutely necessary for online monitoring and maintenance.

Preparation:

1. The inverter must be powered up with battery or grid power.
2. A router with internet access to the website www.semsportal.com is required.

1

1. Connect Solar-Wi-Fi* to your PC or smart phone (* its name is the last 8 characters of the inverter's serial number); Password:12345678.
2. Open your browser and logon to 10.10.100.253 Admin (User): admin; Password: admin.
3. Then click "OK".

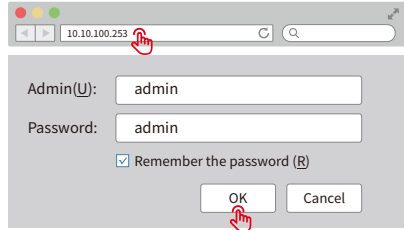

2

1. Click "Start Setup" to choose your router.
2. Then click "Next".

Device information

Firmware version	1.6.9.3.38.2.1.38
MAC address	60:C5:A8:60:33:E1
Wireless AP mode	Enable
SSID	Solar-Wi-Fi
IP address	10.10.100.253
Wireless STA mode	Disable
Router SSID	WiFi_Bum-in
Encryption method	WAP/WAP2-PSK
Encryption algorithm	AES
Router Password	WiFi_Bum-in

A "cannot join the network" error may be caused by:

No router, weak Wi-Fi signal, or the password is not correct

★ **Help: The wizard will help you to complete setup within one minute.**

Start Setup

Please select your current wireless network

	SSID	AUTH/ENCRY	RSSI	Channel
<input type="radio"/>	Wi-Fi_Bum-in	WPAPSKWPA2PSK/TKIPAES	66	1
<input type="radio"/>	Wi-Fi_Bum-in	WPAPSKWPA2PSK/TKIPAES	100	1
<input type="radio"/>	Wi-Fi_Bum-in	WPAPSKWPA2PSK/TKIPAES	70	1
<input type="radio"/>	Wi-Fi_Bum-in2	WPAPSKWPA2PSK/TKIPAES	72	1

Refresh

★ **Help:** When the RSSI of the selected Wi-Fi network is below 15%, the connection may be unstable. Please select another available network or decrease the distance between the device and router. If your wireless router does not broadcast its SSID, please click "Next" and manually add the wireless network.

Back

Next

3

1. Fill in the password of the router, then click "Next".
2. Click "Complete".

Add the wireless network manually

Network name (SSID)	Wi-Fi-Test
Encryption method	WPA/WPA2-PSK
Encryption algorithm	AES

Please enter the wireless network password:

Password (8-63 characters)	Router password
	Show psk

Note: The SSID and password are case sensitive. Please make sure all parameters of the wireless network match those of the router, including the password.

Back

Next

Save success!

Click "Complete". the current configuration will take effect after a restart.

If you still need to configure the other pages of information, please proceed to complete your required configuration.

The configuration is complete. You can now log on to the Management page to restart the device by clicking on the "OK" button.

Click Confirm to complete?

Back

Complete



Note:

1. Please make sure the password and encryption method/algorithm are the same as those of the router.
2. If everything went well, the WiFi indicator on the inverter will change from a double blink to 4 blink and then to a steady status, which means that the WiFi has successfully connected to the server.

WiFi Reset & Reload

WiFi reset means restarting the WiFi module. The WiFi settings will automatically be reprocessed and saved. WiFi Reload means setting the WiFi module to the default factory settings.

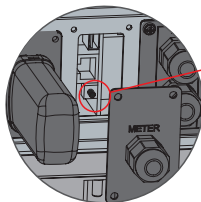
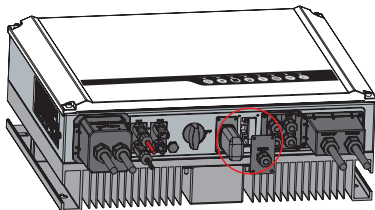

WiFi Reload Button

WiFi reset

Short press the reset button.
The WiFi LED will blink for a few seconds.

WiFi reload

Long press the reset button more than 3s.
The WiFi indicator will double blink until the WiFi is configured again.

Note:

Wi-Fi reset & reload function is only used when:

1. Wi-Fi loses connection to internet or cannot connect to SolarGo App successfully.
2. Cannot find "Solar-WiFi signal" or have other Wi-Fi configuration problems.
3. Please do not use this button if Wi-Fi monitoring works well.
4. If you need to replace the module, please use the unlock tool.

3.2 SolarGo

SolarGo is an external monitoring and configuration application for hybrid inverters and is used on smart phones or tablets for both Android and iOS systems. The main functions are listed as below:

1. Configure the system to customize functions by the user.
2. Monitor and check the performance of the hybrid system.
3. Access and change the regional settings.
4. Check the inverter firmware version.
5. Set export power limit.

Search SolarGo in Google Play or Apple App Store, or scan the QR code to download the app.

Operation steps are the same for Android system and iOS system although the two interfaces are slightly different.

For more detailed operation instructions, please refer to SolarGo user manual in www.goodwe.com.



SolarGo App

Note:

For Australian customers please select from Australia Region A/B/C to comply with AS/NZS 4777.2:2020. Contact local grid operator to see which Region to select. After setting the safety region, some parameters in the inverter system will take effect according to the corresponding safety regulations, such as PU curve, QU curve, trip protection, etc. For Australian and European users, if you need to change the configuration parameters, please refer to the SolarGo user manual.

3.3 CEI Auto-Test Function

The PV auto-test function of CEI is integrated into the SolarGo App to satisfy Italian safety requirements. For detailed instructions regarding this function, please refer to "SolarGo Operation Instructions".

3.4 Startup/shutdown Procedure

DC switch is used to cut off PV input power while the breaker equipped on the battery is used to cut off battery power.

When you want to shut down the inverter during an event, you shall turn off the inverter DC switch and the battery DC breaker.

When you want to start-up the inverter after rectification, you shall turn on the inverter DC switch and the battery DC breaker.

3.5 SEMS Portal

SEMS Portal is an online monitoring system. After completing the installation of communication connection, you can access www.semsportal.com or download the app by scanning the QR code to monitor your PV plant and device.

Please contact the after-sales for more operation of SEMS Portal.



SEMS Portal App

04 OTHER

4.1 Error Messages.

The error messages below will be displayed on SolarGo App or reported by e-mail if an error occurs.

ERROR MESSAGE	EXPLANATION	REASON	SOLUTIONS
Utility Loss	Public grid power is not available (power lost or on-grid connection fails)	Inverter does not detect the connection of grid	<ol style="list-style-type: none"> 1. Check (use multi-meter) if AC side has voltage . Make sure grid power is available. 2. Make sure AC cables are connected tightly and well. 3. If all is well, please try to turn off AC breaker and turn on again in 5 mins.
VAC Failure	Grid voltage is not within permissible range	Inverter detects that AC voltage is beyond the normal range required by the safety country	<ol style="list-style-type: none"> 1. Make sure safety country of the inverter is set right. 2. Check (use multi-meter) if the AC voltage (Between L & N) is within a normal range (also on AC breaker side) <ol style="list-style-type: none"> a. If the AC voltage is high, then make sure the AC cable complies with that required on user manual and the AC cable is not too long. b. If the voltage is low, make sure the AC cable is connected well and the jacket of the AC cable is not compressed into the AC terminal. 3. Make sure the grid voltage of your area is stable and within normal range.
FAC Failure	Grid frequency is not within permissible range	Inverter detects that the grid frequency is beyond the normal range required by the safety country	<ol style="list-style-type: none"> 1. Make sure the safety country of the inverter is set right. 2. If safety country is right, then please check on the inverter display if AC frequency (Fac) is within a normal range. 3. If FAC failure only appears a few times and is resolved soon, it should be caused by occasional grid frequency instability.
Over Temperature	Temperature inside of the inverter is too high	The inverter's working environment leads to a high temperature condition	<ol style="list-style-type: none"> 1. Try to decrease surrounding temperature. 2. Make sure the installation complies with the instruction on inverter user manual. 3. Try to close the inverter for 15 mins, then start up again.



Isolation Failure	Ground insulation impedance of PV string is too low	Isolation failure could be caused by multiple reasons like that the PV panels are not grounded well, DC cable is broken, PV panels are aged or surrounding humidity is comparatively heavy, etc.	<ol style="list-style-type: none"> 1. Use multi-meter to check if the resistance between earth & inverter frame is close to zero. If it's not, please ensure that the connection is well. 2. If the humidity is too high, isolation failure may occur. 3. Check the resistance between PV1+/PV2+/PV3+/PV4+/BAT+/PV- to earth. If the resistance is lower than the minimum isolation resistance shown in the table(chapter 2.4.2) , check the system wiring connection. 4. Try to restart the inverter. Check if the fault still occurs. If not, it means it is caused by an occasional situation, or contact after-sales
Ground Failure	Ground leakage current is too high	Ground failure could be caused by multiple reasons like that the neutral cable on the AC side is not connected well or the surrounding humidity is comparatively heavy, etc.	Check (use multi-meter) if there is voltage (normally should be close to 0V) between earth & inverter frame. If there is a voltage, it means the neutral & ground cables are not connected well on the AC side. If it happens only in the early morning/ dawn /rainy days with higher air humidity and is recovered soon, it should be normal.
Relay Check Failure	Self checking of relay failure	Neutral & ground cables are not connected well on AC side or just an occasional failure	Check (use multi-meter) if there is high voltage (normally should be lower than 10V) between N & PE cable on the AC side. If the voltage is higher than 10V, it means the Neutral & ground cable are not connected well on AC side or restart inverter.
DC Injection High	/	The inverter detects a higher DC component in AC output	.Try to restart the inverter, check if it still occurs. If not, it is just an occasional situation. Otherwise, contact after-sales immediately.
EEPROM R/W Failure	/	Caused by a strong external magnetic field etc.	Try to restart the inverter, check if it still occurs. If not, it is just an occasional situation. Otherwise, contact after-sales immediately.
SPI Failure	Internal communication failure	Caused by a strong external magnetic field etc.	Try to restart the inverter, check if it still occurs. If not, it is just an occasional situation. Otherwise, contact after-sales immediately.

DC Bus High	BUS voltage is over-high	/	Try to restart the inverter. Check if the fault still occurs. If not, it means it is caused by an occasional situation, or contact after-sales.
Back-Up Over Load	Back-up side is over loaded	Total back-up load power is higher than the back-up nominal output power	Decrease back-up loads to make sure the total load power is lower than back-up nominal output power.

4.2 Troubleshooting

Checks Before Turning On AC Power

- **Battery connections:** Confirm that the connections between the inverter and battery: the polarities (+/-) are not reversed. Refer to figure 4.2-1
- **PV input connection:** Confirm the connections between the inverter and PV panels: the polarities (+/-) are not reversed. Refer to figure 4.2-2.
- **On-grid & backup connections:** Confirm that the on-grid is connected to the power grid and that the backup is connected to the loads: the polarities (e.g. L/N are in sequence) are not reversed. Refer to figure 4.2-3.
- **Smart Meter & CT connections:** Make sure that the Smart Meter and CT are connected between the house loads and the grid, and follow the Smart Meter direction sign on the CT. Refer to figure 4.2-4.

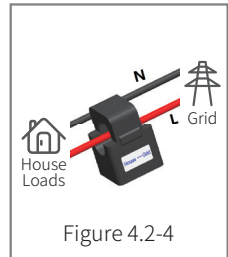
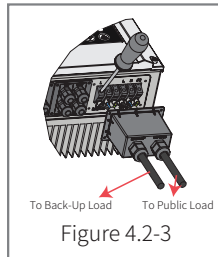
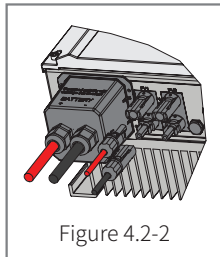
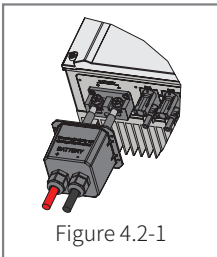

Checks At Startup And Turning On AC Power

Battery settings, BMS communication and safety country setting:

After connecting the Solar-Wi-Fi* (*The Wi-Fi signal is named as the last 8 characters of the inverter's serial number.). Check the SolarGo App "Param" to make sure that the battery type is the same as was installed. Also check that the "Safety Country" setting is correct. If it is not correct, please set it correctly in "Set".

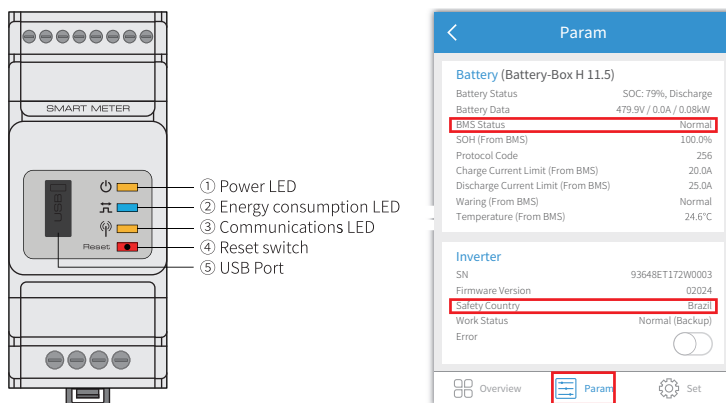

Note: For compatible lithium batteries, the BMS status will display "Normal" after selecting the correct battery company.

Problems During Operation

The inverter does not start up with battery only

Solution:

Make sure that the battery voltage is greater than 180V. Otherwise, the battery cannot start the inverter.

The inverter did not start up with PV only

Solution:

1. Make sure the PV voltage is greater than 180 (230 V is needed to enter on-grid mode).
2. Make sure that, for the connection between the inverter and PV panels, the polarities are (+/-) not reversed.

The hybrid inverter does not discharge or output without the PV or when the PV power is less than the load power

Solution:

1. Check whether the communications between the inverter and Smart Meter are OK.
2. Make sure the load power is greater than 150W.
 - a. The battery will not discharge continuously unless the load power is greater than 150W.
 - b. If the battery does not discharge when the Meter power is greater than 150W, please check the Smart Meter & CT connections and directions.
3. Make sure the SOC (State of discharge) is greater than 1-DOD (Depth of discharge). Or, if the battery is discharged to below 1-DOD, the battery will only discharge again when SOC is charged to $(20\% + 1 - \text{DOD}) / 2$ (if battery discharge is needed immediately, the user should restart the battery).
4. Check on the APP whether the charge time has already been set because during the charge time, the battery will not discharge (battery will charge in priority during times of concurrent charge/discharge).

The battery does not charge when the PV power is greater than the load power

Solution:

1. Check if charge voltage on App(in "param") is properly set (for lead-acid battery), as battery cannot charge if battery voltage reaches charge voltage.
2. Check the discharge time setting on App.
3. Check if battery is fully charged or not, or if battery voltage reaches "charge voltage" or not.

High power fluctuations during battery charge or discharge

Solution:

1. Check if there are fluctuations in load power.
2. Check if there are fluctuations in PV power.

Battery does not charge

Solution:

1. Make sure that BMS communications are OK on the SolarGo App.
2. Check if the CT is connected at the right position and is connected in the right direction per the User Manual.
3. Check if the total load power is significantly higher than the PV power.

Questions & Answers (Q & A)

About the Wi-Fi Configuration

Q: Why can't I find the Solar-Wi-Fi* signal on mobile devices?

A: Normally the Solar-Wi-Fi* signal can be seen immediately after inverter has powered up. However, the Solar-Wi-Fi signal will disappear when the inverter connects to the internet. If changes to the settings are required to connect to the router for changes. If you cannot find the Wi-Fi signal or connect to the router, please try to reload the Wi-Fi.

Q: Why can't I connect to the Solar-Wi-Fi* signal on my phone?

A: The Wi-Fi module can only connect to one device at a time. If the signal is already connected to another device at the same time, you will not be able to connect to the signal.

Q: Why does the Wi-Fi module fail to connect to network after I choose the right router hotspot and enter the right passwords?

A: It's possible that there are special characters not supported by module in the hotspot passwords. Please modify the password to consist of only Arabic numerals or uppercase / lowercase letters.

About Battery Operation

Q: Why does the battery not discharge when the grid is not available but it discharges normally when the grid is available?

A: On the APP, the off-grid output and backup function should be turned on to force the battery to discharge under off-grid mode.

Q: Why is there no output on the backup side?

A: For backup supply, "Backup Supply" on the SolarGo App must be turned on. In off-grid mode or when the grid power is disconnected, the "Off-Grid Output Switch" function must be turned on as well.

Note: When turning the "Off-Grid Output Switch" on, do not restart the inverter or battery. Otherwise, the function will be switched off automatically.

Q: Why does the battery SOC suddenly jump to 95% on the Portal?

A: This normally happens when BMS communications fail when using lithium batteries. If the batteries enter float charge mode, the SOC is automatically reset to 95%.

Q: The battery cannot be fully charged to 100%?

A: The battery will stop charging when the battery voltage reaches the charge voltage set in the SolarGo App.

Q: Why does the battery switch always trip when it starts up (lithium battery)?

A: The switch of the lithium battery trips because of following reasons:

1. BMS communication fails.
2. The battery SOC is too low and the battery trips to protect itself.
3. An electrical short-circuit has occurred on the battery connection side. Alternatively, for other reasons, Please contact the after-sales department.

Q: Which battery should I use for the inverter?

A: For the inverter, it can connect to lithium batteries which have compatibility with inverters with nominal voltages from 180 V to 600 V. For compatible lithium batteries, please refer to the battery list in the SolarGo App.

About SolarGo Operation And Monitoring

Q: Why can't I save settings on the SolarGo App?

A: This could be caused by losing the connection to Solar-Wi-Fi*.

1. Make sure you have already connected to Solar-Wi-Fi* (make sure that no other devices are connected) or to the router (if Solar-Wi-Fi* is connected to the router). The APP homepage shows the connections.
2. Make sure you restart the inverter 10 mins after you have changed any settings because the inverter will save the settings every 10 mins while operating in normal mode. We recommend that parameter settings be changed when the inverter is in wait mode.

Q: Why are the data displayed on the homepage different from the param page, like charge/discharge, PV value, load value, or grid value?

A: The data refresh frequency is different, so there will be data discrepancies between different pages on the APP as well as between these shown on the portal and APP.

Q: Some columns show NA, like battery SOH, etc. Why does that happen?

A: NA means that the App has not received data from the inverter or server because of communication problems, such as battery communications and the communications between inverter and the App.

About the Smart Meter And Power Limit Function

Q: How to activate the output power limit function?

A: This function can be activated by following these steps:

1. Make sure the Smart Meter connections and communications are functioning correctly.
2. Turn on the export power limit function and set the maximum output power to the grid on the APP.

Note: Even if the output power limit is set to 0W, there might still be a deviation of a maximum of 100 W when exporting to the grid.

Q: Why is there still power exporting to the grid after I have set the power limit to 0 W?

A: The export limit could theoretically be 0W but there will be a deviation of around 50–100 W.

Q: Can I use other meter brands to take over from the Smart Meter in the system or to change settings in Smart Meter?

A: No, because the communication protocol is integrated into the inverter and Smart Meter, other meter brands cannot communicate. Also, any change to the manual settings could cause a meter communication failure.

Q: What is the maximum current allowed to pass through the CT on the Smart Meter?

A: The maximum current for the CT is 120A.

Other Questions

Q: Is there a quick way to make the system work?

A: For the shortest resolution, please refer to "ES Quick Installation Instructions" and to the "SolarGo App Instructions".

Q: What kind of load can I use to connect to the backup side?

A: Please refer to User Manual on page 12.

Q: Will the warranty of the inverter still be valid if, for some special conditions, we cannot follow 100% of the User Manual instructions for installation or operation?

A: Normally we still provide technical support for problems caused by not following the instructions in the User Manual. However we cannot guarantee any replacements or returns. So, if there are any special conditions for which you cannot follow the instructions 100%, please contact the after-sales department for suggestions.

4.3 Disclaimer

The inverters are transported, used and operated under environmental and electrical conditions. The manufacturer has the right to not provide after-sales services or assistance under the following conditions:

- The inverter is damaged during transfer.
 - The inverter is out of the warranty year and an extended warranty is not purchased.
 - The inverter is installed, refitted, or operated in improper ways without authorization from the manufacturer.
 - The inverter is installed or used under improper environmental or technical conditions (as mentioned in this User Manual) and without authorization from manufacturer.
 - The installation or configuration of the inverter does not follow the requirements mentioned in this User Manual.
 - The inverter is installed or operated contrary to the requirements or warnings mentioned in this User Manual.
 - The inverter is broken or damaged by any force majeure, such as lightning, earthquake, fire hazard, storm and volcanic eruption etc.
 - The inverter is disassembled, changed or updated on software or hardware without authorization from the manufacturer.
 - The Inverter is installed, used, or operated against any related provisions contained in international or local policies or regulations.
 - Any incompatible batteries, loads or other devices are connected to the system.
 - Specifications are subject to change without notice. Every effort has been made to make this document complete, accurate and up-to-date. However, GoodWe may need to make some improvements under certain circumstances without advance notice. GoodWe shall not be responsible for any loss caused by this document including, but not limited omissions errors, typographical errors, arithmetical errors or listing errors in this document.
- If you have any questions or suggestions, please contact GoodWe after-sale.

Note: The manufacturer retains the right to explain all of the contents in this User Manual. To insure IP66, the inverter must be sealed well; please install the inverters within one day of unpacking; otherwise, please seal all unused terminals /holes; unused terminals/holes are not allowed to remain open; and confirm that there is no risk of water or dust entering any terminals/holes.



Maintenance

Maintaining Item	Maintaining Method	Maintaining Period
System Clean	Check the heat sink, air intake, and air outlet for foreign matter or dust.	Once 6-12 months
DC Switch	Turn the DC switch on and off ten consecutive times to make sure that it is working properly.	Once a year
Electrical Connection	Check whether the cables are securely connected. Check whether the cables are broken, or whether there is any exposed copper core.	Once 6-12 months
Sealing	Check whether all the terminals and ports are properly sealed. Reseal the cable hole if it is not sealed or too big.	Once a year
THDi Test	For Australia requirements, in the THDi test, there should add Zref between inverter and mains. L: $0.24 \Omega + j0.15 \Omega$; N: $0.16 \Omega + j0.10 \Omega$ L: $0.15 \Omega + j0.15 \Omega$; N: $0.1 \Omega + j0.1 \Omega$	As needed

• WiFi module: Replace or remove the WiFi module using the WiFi module remover, which is delivered in the package. Remove the communication terminal next to the WiFi module first. Place the remover horizontally on the WiFi module, then turn the remover to 90° to fasten it and the module together. Press the remover and pull the module to remove it as the following figure shows.

Notice: If you need to repair or replace parts, contact the after sales service.

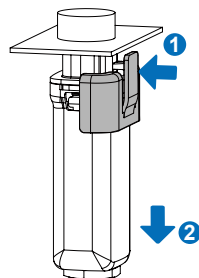

4.4 Technical Parameters

Technical Data	GW3648D-ES ^{*9}	GW5048D-ES ^{*10}
Battery Input Data		
Battery Type ^{*1}	Li-Ion	
Nominal Battery Voltage (V)	48	
Battery Voltage Range (V)	40~60	
Max. Continuous Charging Current (A) ^{*1}	75	100
Max. Continuous Discharging Current (A) ^{*1}	75	100
Max. Charge Power (W)	3,600	4,600
Max. Discharge Power (W)	3,600	4,600
PV String Input Data		
Max. Input Power (W)	4,600	6,500
Max. Input Voltage (V)	580	
MPPT Operating Voltage Range (V)	125~550	
MPPT Voltage Range at Nominal Power (V)	140~500	190~500
Start-up Voltage (V)	125	
Nominal Input Voltage (V)	360	
Max. Input Current per MPPT (A)	14/14 or 11/11 ^{*11}	
Max. Short Circuit Current per MPPT (A)	17.5/17.5 or 13.8/13.8 ^{*11}	
Max. Backfeed Current to The Array (A)	0	
Number of MPP Trackers	2	
Number of Strings per MPPT	1	
AC Output Data (On-grid)		
Nominal Apparent Power Output to Utility Grid (VA) ^{*7}	3,680	5,000
Max. Apparent Power Output to Utility Grid (VA) ^{*2}	3,680	5,000
Nominal Apparent Power from Utility Grid (VA)	7,360	9,200
Max. Apparent Power from Utility Grid (VA)	7,360	9,200

Nominal Output Voltage (V)	230	
Output Voltage Range (V)	0~300	
Nominal AC Grid Frequency (Hz)	50/60	
AC Grid Frequency Range (Hz)	45~65	
Max. AC Current Output to Utility Grid (A)	16.0*8	24.5
Max. AC Current From Utility Grid (A)	32.0	40.0
Max. Output Fault Current (Peak and Duration) (A)	43@0.2s	
Inrush Current (Peak and Duration) (A)	60@3μs	
Power Factor	~1 (Adjustable from 0.8 leading to 0.8 lagging)	
Max. Total Harmonic Distortion	<3%	<3%
Maximum Output Overcurrent Protection (A)	30	30
AC Output Data (Back-up)		
Back-up Nominal Apparent Power (VA)	3,680	4,600
Max. Output Apparent Power (VA)*3	3,680 (5,520@10sec)	4,600 (6,900@10sec)
Nominal Output Current (A)	16.0	20.0
Max. Output Current (A)	16.0	20.0
Max. Output Fault Current (Peak and Duration) (A)	43@0.2s	
Inrush Current (Peak and Duration) (A)	60@3μs	
Maximum Output Overcurrent Protection (A)	30	
Nominal Output Voltage (V)	230 (±2%)	
Nominal Output Frequency (Hz)	50/60 (±0.2%)	
Output THDv (@Linear Load)	<3%	
Efficiency		
Max. Efficiency	97.6%	
European Efficiency	97.0%	
Max. Battery to AC Efficiency	94.0%	
MPPT Efficiency	99.9%	

Protection		
PV Insulation Resistance Detection	Integrated	
Residual Current Monitoring	Integrated	
PV Reverse Polarity Protection	Integrated	
Anti-islanding Protection	Integrated	
AC Overcurrent Protection	Integrated	
AC Short Circuit Protection	Integrated	
AC Overvoltage Protection	Integrated	
General Data		
Operating Temperature Range (°C)	-25~+60	
Relative Humidity	0~95%	
Max. Operating Altitude (m)	3000	
Cooling Method	Natural Convection	
User Interface	LED, APP	
Communication with BMS ⁴	RS485, CAN	
Communication with Meter	RS485	
Communication with Portal	WiFi	
Weight (kg)	28.0	30.0
Dimension (W×H×D mm)	516×440×184	
Noise Emission (dB)	<25	
Topology	Non-isolated	
Self-consumption at Night (W)	<13	
Ingress Protection Rating	IP65	
DC Connector	MC4 (4~6 mm ²)	
AC Connector	Feed-Through Terminal Blocks UW10	
Environmental Category	4K4H	
Overvoltage Category	DC II / AC III	
Protective Class	I	
Storage Temperature (°C)	-40~+85	



The Decisive Voltage Class (DVC)	Battery: A PV: C AC: C COM: A
Mounting Method	Wall Mounted
Active Anti-islanding Method	AFDPF+AQDPF ^{*5}
Type of Electrical Supply System	Single Phase TN/TT System
Country of Manufacture	China
Certifications & Standards^{*6}	
Grid Regulation	VDE-AR-N 4105, VDE 0126-1-1, EN 50549-1, G98, G100, CEI 0-21, AS/NZS4777.2, NRS 097-2-1
Safety Regulation	IEC62109-1&2, IEC62040-1
EMC	EN61000-6-1, EN61000-6-2, EN61000-6-3, EN61000-6-4, EN 61000-4-16, EN 61000-4-18, EN 61000-4-29
<p>*1: The actual charge and discharge current also depends on the battery.</p> <p>*2: 4600 for VDE 0126-1-1 &VDE-AR-N4105 &NRS 097-2-1, 5100 for CEI 0-21(GW5048D-ES); 4050 for CEI 0-21(GW3648D-ES).</p> <p>*3: Can be reached only if PV and battery power is enough.</p> <p>*4: CAN communication is configured by default. If 485 communication is used, please replace the corresponding communication line.</p> <p>*5: AFDPF: Active Frequency Drift with Positive Feedback, AQDPF: Active Q Drift with Positive Feedback.</p> <p>*6: Not all certifications & standards listed, check the official website for details.</p> <p>*7: 4600 for VDE 0126-1-1 &VDE-AR-N4105 &NRS 097-2-1, 4600 for CEI 0-21(GW5048D-ES).</p> <p>*8: 18 for CEI 0-21.</p> <p>*9: FOR AUSTRALIA ONLY. Model GW3648D-ES inverters are designed without DC switch. For inverters designed with DC switch, the model name should be GW3648C-ES.</p> <p>*10: FOR AUSTRALIA ONLY. Model GW5048D-ES inverters are designed without DC switch. For inverters designed with DC switch, the model name should be GW5048C-ES.</p> <p>*11: Subject to the nameplate.</p>	

4.5 Quick Checklist To Avoid Dangerous Conditions

1. The inverter must not be installed near flammable or explosive materials or near equipment with strong electromagnetic fields.
2. Remember that this inverter is heavy! Please be careful when lifting from the package.
3. Make sure that the battery breaker is off and that the nominal battery voltage meets ES specifications before connecting the battery to the inverter; make sure that the inverter is totally isolated from both PV and AC power.
4. Make sure that the inverter is totally isolated from all DC or AC power before connecting the AC cable.
5. Make sure the AC cable is totally isolated from AC power before connecting the Smart Meter and CT.



Appendix

Protection category definition

Moisture location category definition

Moisture Parameters	Level		
	3K3	4K3	4K4H
Temperature Range	0~+40°C	-33~+40°C	~20~+55°C
Moisture Parameters	5%~85%	15%~100%	4%~100%

Environment category definition

Environment Condition	Ambient Temperature	Relative Humidity	Applied to
Outdoor	-20~50°C	4%~100%	PD3
Indoor Unconditioned	-20~50°C	5%~95%	PD3
Indoor conditioned	0~40°C	5%~85%	PD2

Overvoltage category definition

Category I	Applies to equipment connected to a circuit where measures have been taken to reduce transient overvoltage to a low level.
Category II	Applies to equipment not permanently connected to the installation. Examples are appliances, portables tools and other plug-connected equipment.
Category III	Applies to a fixed equipment downstream, including the main distribution board. Examples are switchgear and other equipment in an industrial installation.
Category IV	Applies to equipment permanently connected at the origin of an installation (upstream of the main distribution board). Examples are electricity meters, primary over-current protection equipment and other equipment connected directly to outdoor open lines.

Pollution degree definition

Pollution Degree I	No pollution or only dry, non-conductive pollution occurs. The pollution has no influence.
Pollution Degree II	Normally only non-conductive pollution occurs. Occasionally, however, a temporary conductivity caused by condensation must be expected.
Pollution Degree III	Conductive pollution occurs, or dry, non-conductive pollution occurs, which becomes conductive due to condensation, which is expected.
Pollution Degree IV	Persistent conductive pollution occurs, for example, the pollution caused by conductive dust, rain or snow.

GoodWe Technologies Co., Ltd.

 No. 90 Zijin Rd., New District, Suzhou, 215011, China

 www.goodwe.com

 service@goodwe.com



Local Contacts