



PYLONTECH



Lithium-Ion Phosphate Energy Storage System Force-L2 Operation Manual

Information Version: 2.4
5PMPA08-00217

This manual introduces Force-L2 from Pylontech. Force-L2 is a 48V DC Lithium-Ion Phosphate Battery storage system. Please read this manual before you install the battery and follow the instruction carefully during the installation process. Any confusion, please contact Pylontech immediately for advice and clarification.

Content

1.	SAFETY PRECAUTIONS	1
	1.1 Symbols	1
	1.2 Before Connecting	4
	1.3 In Using	4
2.	SYSTEM INTRODUCTION	5
	2.1 Product Introduction	5
	2.2 Specifications	5
	2.2.1 System parameters	5
	2.2.2 Battery Module (FL4874M)	7
	2.2.3 Control Module FC0048M-100S (internal power supply)	8
	2.3 System Diagram	12
3.	INSTALLATION	13
	3.1 Tools	13
	3.2 Safety Gear	13
	3.3 System Working Environments Checking	14
	3.3.1 Cleaning	14
	3.3.2 Temperature	14
	3.3.3 Fire-extinguisher System	14
	3.3.4 Grounding System	14
	3.4 Handling and placement	14
	3.4.1 Handling and placement of the base	14
	3.4.2 Selection of installation sites	14
	3.4.4 Mounting and installation of the base	16
	3.4.5 Battery Modules and Control Module (BMS) pile up	17
	3.4.6 Installation of the fixed metal bracket for the system	18
	3.4.7 Locking of control module's fix screw of left and right side	19
	3.5 Cables connection	20
	3.5.1 Grounding	22
	3.5.2 Cables	23
	3.5.3 System turns on	24
	3.5.4 System turns off	25
4.	SYSTEM DEBUG	26

5.	MAINTENANCE	27
5.1	Trouble Shooting:.....	27
5.2	Replacement of main component	28
5.2.1	Replacement of Battery Module	28
5.2.2	Replacement of Control Module (BMS)	30
5.3	Battery Maintenance.....	31
6.	STORAGE RECOMMENDATIONS	33
7.	SHIPMENT	33

1. Safety Precautions

Incorrect operation or work may cause:

- injury or death to the operator or a third party;
- damage to the system hardware and other properties belonging to the operator or a third party.





Skills of Qualified Person









Qualified personnel must have the following skills:

- Training in the installation and commissioning of the electrical system, as well as the dealing with hazards;
- Knowledge of the manual and other related documents;
- knowledge of the local regulations and directives.

1.1 Symbols

Symbole

	Danger	Lethal voltage! <ul style="list-style-type: none"> ● Battery strings will produce DC power and can cause a lethal voltage and an electric shock. ● Only qualified person can perform the wiring of the battery strings.
	Warning	Risk of battery system damage or personal injury <ul style="list-style-type: none"> ● DO not pull out the connectors while the system is working! ● De-energize from all multiple power sources and verify that there is no voltage.
	Caution	Risk of battery system failure or life cycle reduces.
	Symbol in label	Read the product and operation manual before operating the battery system!
	Symbol in label	Danger! Safety!

	Symbol in label	Warning electric shock!
	Symbol in label	Do not place near flammable material
	Symbol in label	Do not reverse connection the positive and negative.
	Symbol in label	Do not place near open flame
	Symbol in label	Do not place at the children and pet touchable area.
	Symbol in label	Recycle label.
	Symbol in label	Label for Waste Electrical and Electronic Equipment (WEEE) Directive (2012/19/EU)
	Symbol in label	The certificate label for EMC.

	Symbol in label	The certificate label for Safety by TÜV SÜD.
 <p>Type Approved Safety Regular Production Surveillance www.tuv.com ID 0000000000</p>	Symbol in label	The certificate label for Safety by TÜV Rheinland.



Danger: Batteries deliver electric power, resulting in burns or a fire hazard when they are short circuited, or wrongly installed.

Danger: Lethal voltages are present in the battery terminals and cables. Severe injuries or death may occur if the cables and terminals are touched.



Warning: Do not open or deform the battery module;

Warning: Whenever working on the battery, wear suitable personal protective equipment (PPE) such as rubber gloves, rubber boots and goggles.

Warning: Force-L2 system working temperature range: 0°C ~ 50°C; Optimum temperature: 18°C ~ 28°C. Out of the working temperature range may cause the battery reduces the cycle of life even cause the battery system over / low temperature alarm or protection. It will affect the warranty.



Warning: For battery installation, the installer shall refer to NFPA70 or similar local installation standard for operation.



Caution: Improper settings or maintenance can permanently damage the battery.

Caution: Incorrect inverter parameters will lead to the premature aging of battery.

Reminding



- 1) It is very important and necessary to read the user manual carefully (in the accessories) before installing or using battery. Failure to do so or to follow any of the instructions or warnings in this document can result in electrical shock, serious injury, or death, or can damage battery, potentially rendering it inoperable.
- 2) If the battery is stored for long time, it is required to charge them every six months, and the SOC should be no less than 90%;
- 3) Battery needs to be recharged within 12 hours, after fully discharged;
- 4) Do not expose cable outside;

- 5) All the battery terminals must be disconnected for maintenance;
- 6) Please contact the supplier within 24 hours if there is something abnormal.
- 7) Do not use cleaning solvents to clean battery;
- 8) Do not expose battery to flammable or harsh chemicals or vapors;
- 9) Do not paint any part of battery, include any internal or external components;
- 10) Do not connect battery with PV solar wiring directly;
- 11) Do not open, repair or disassemble the battery except staffs from Pylontech or authorized by Pylontech. We do not undertake any consequences or related responsibility which because of violation of safety operation or violating of design, production and equipment safety standards.
- 12) The warranty claims are excluded for direct or indirect damage due to items above.
- 13) Any foreign object is prohibited to insert into any part of battery.



1.2 Before Connecting

- 1) After unpacking, please check product and packing list first, if product is damaged or lack of parts, please contact with the local retailer;
- 2) Before installation, be sure to cut off the grid power and make sure the battery is in the turned-off mode;
- 3) Wiring must be correct, do not mistake the positive and negative cables, and ensure no short circuit with the external device;
- 4) It is prohibited to connect the battery and AC power directly;
- 5) The embedded BMS in the battery is designed for 48VDC, please DO NOT connect battery in series;
- 6) Battery system must be well ground and the resistance must be less than 100mΩ;
- 7) Please ensured the electrical parameters of battery system are compatible to related equipment;
- 8) Keep the battery away from water and fire.



1.3 In Using

- 1) If the battery system needs to be moved or repaired, the power must be cut off and the battery is completely shut down;
- 2) It is prohibited to connect the battery with different type of battery.
- 3) It is prohibited to put the batteries working with faulty or incompatible inverter;
- 4) It is prohibited to disassemble the battery (QC tab removed or damaged);
- 5) In case of fire, only dry powder fire extinguisher can be used, liquid fire extinguishers are prohibited;

2. System Introduction

2.1 Product Introduction

Force-L2 is a 48VDC battery storage system based on lithium iron phosphate battery, which is one of the new energy storage products developed and produced by Pylontech. It can be used to provide reliable power for various types of equipment and systems. Force-L2 is especially suitable for those application scenes which require high power energy, limited installation space, restricted load-bearing and long cycle life.

2.2 Specifications

2.2.1 System parameters



Product Type	FORCE-L2 (48V148AH)	FORCE-L2 (48V222AH)	FORCE-L2 (48V296AH)
Cell Technology	Li-ion (LFP)		
Battery System Capacity(kWh)	7.10	10.65	14.20
Battery System Voltage (VDC)	48		
Battery System Capacity (Ah)	148	222	296
Battery Controller Name	FC0048M-100S		
Battery Module Name	FL4874M		
Battery Module Quantity(pcs)	2	3	4
Battery Module Capacity(kWh)	3.552		
Battery Module Voltage (VDC)	48		
Battery Module Capacity (AH)	74		
Battery Module Cell Series Quantity(pcs)	15		
Battery System Charge Upper-Voltage (VDC)	53.5		
Battery System Charge Current (Amps, Standard)	30	45	60
Battery System Charge Current (Amps, Normal)	75	100	100
Battery System Charge Current (Amps, Max.@15S)	110		
Battery System Discharge lower-Voltage (VDC)	44.5		
Battery System Discharge Current (Amps, Standard)	30	45	60
Battery System Discharge Current (Amps, Normal)	75	100	100
Battery System Discharge Current (Amps, Max.@15S)	110		
Efficiency (% , ≤0.5C-rate)	96		
Depth of Discharge(%)	95		
Dimension(W*D*H,mm)	450*296*822	450*296*1120	450*296*1415
Communication	RS485\CAN		
Protection Class	IP55		
Weight (kg)	82	117.5	153
Operation Life (year)	15+		
Operation Temperature (°C)	0~50		
Storage Temperature (°C)	-20~60		
Altitude(M)	<2,000		
Product Certificate	VDE2510-50, IEC62619, CE RED, IEC62477-1, CEC		
Transfer Certificate	UN38.3		
1) Battery Controller Dimensions(W*D*H, mm)	450×296×190		
2) Battery Module Dimensions (W*D*H, mm)	450×296×296		
3) Battery bottom base Dimensions(W*D*H, mm)	450×296×40		

2.2.2 Battery Module (FL4874M)



Product Type	FL4874M
Cell Technology	Li-ion (LFP)
Battery Module Capacity (kWh)	3.552
Battery Module Voltage (VDC)	48
Battery Module Capacity (Ah)	74
Battery Module Serial Cell Quantity (pcs)	15
Battery Cell Voltage (VDC)	3.2
Battery Cell Capacity (AH)	37
Dimension (W*D*H, mm)	450*296*296
Weight (kg)	35.5
Operation Life (year)	15+
Operation Cycle Life (cycle)*	8,000
Operation Temperature (°C)	0~50
Storage Temperature (°C)	-20~60
Transportation Certificate	UN38.3

* Operation Cycle Life is defined based on specific operation conditions, for more details please check with Pylontech service team.

**2.2.3 Control Module FC0048M-100S
(internal power supply)**



Control Module (FC0048M-100S) Display Panel



LED Button

	Short Press	Display the LED panel for 20sec.
	Long Press (more than 5sec)	When status LED fast flashes blue ●, loss the button, then it is 115200 baud rate of RS485.
		When status LED fast flashes orange ●, loss the button, then it is 9600 baud rate of RS485.

Status

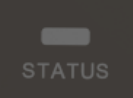
	Blue, flashing.	Power Relay CLOSE. Alarm exist but can work continue.
	Blue, solid.	Power Relay CLOSE. Normal.
	Orange, flashing.	Power Relay OPEN. Normal protection, can recover on its own (Over Voltage, Under Temperature, etc.).
	Orange, solid.	Power Relay OPEN. Important protection, failure, lost efficacy etc. Or failed to assign address. Need trouble shooting.

Battery Module Status

	Blue, flashing.	Alarm exist but can work continue.
	Blue, solid.	Normal.
	Blue, light once.	1~n LED lights on one by one, for address distribution.
	Orange, flashing.	Module offline.
	Orange, solid.	Module protection, failure, etc.
	Orange, 7 LED slow flashing together	Address distribution failure.

System Capacity

Indicate the system SOC.

	Blue, slow flashing.	Each LED indicate 25%SOC. Idle
	Blue, flashing.	Each LED indicate 25%SOC. Discharge
	Blue, lighting.	Each LED indicate 25%SOC. Charge

Remark: Slow flashing: 1.5s ON/0.5s OFF. Flashing 0.5s ON/0.5s OFF.

Fast flashing: 0.1s ON/0.1s OFF.

Control Module (FC0048M-100S) Cable Panel



Power Switch

Switch A (1P). ON: the battery system's controller able to turn on. OFF: whole system turns OFF.
Switch B (2P). Main breaker.



Caution: When the breaker is tripped off because of over current or short circuit, must wait more than 30min then can turn on it again, otherwise may cause the breaker damage.

Start



Start function: press more than 5sec, to turn on controller.
Black start function: when system turn on, and relay is OFF, press more than 10 secs, and relay will turn on for 3 min (depends on conditions).

Wi-Fi

Manufacturer: Pylon Technologies Co., Ltd.

Address: Plant 8, No.505 Kunkai Road, JinXi Town, 215324 Kunshan City, Jiangsu Province, PEOPLE'S REPUBLIC OF CHINA

Importer: XXXX (Located in installed country)

Address: XXXX (Located in installed country)

Maximum Transmitting power: 18dBm

Wireless maximum output power: 20dBm

Operating frequency: 2412-2472MHz

Gain of antenna: Max 3dBi

Modulation system:

DBPSK/DQPSK/CCK(DSSS)

BPSK/QPSK/16QAM/64QAM(OFDM)

Modulating Repetition:

1Mbps/2Mbps/5.5Mbps/11Mbps(DSSS)

6Mbps/9 Mbps/12 Mbps/18 Mbps/24 Mbps/36 Mbps/48 Mbps/54 Mbps(OFDM)

MCS0~MCS7(802.11n 20MHz)

Channel spacing:5MHz

Type of antenna: 2.4G IPEX-SMA Antenna

Power Terminal (+/-)

Connect power cables of battery system with Inverter.

Communication Terminal (RS485 / CAN / RS232 / Link Port 0 / Link Port 1)

RS485 Communication Terminal: (RJ45 port) follow RS485 protocol, for communication between battery system and inverter.

CAN Communication Terminal: (RJ45 port) follow CAN protocol, for communication between battery system and inverter.

Link port0/1 for communication between battery piles.

RS232 Communication Terminal: (RJ45 port) for manufacturer or professional engineer to debug or service.

Definitions of RJ45 Port Pin

	CAN	RS485	RS232
1	---	---	---
2	---	---	---
3	---	---	TX
4	CANH	---	---
5	CANL	---	---
6	GND	---	RX
7	---	RS485A	---
8	---	RS485B	---

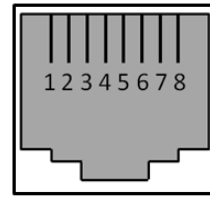

RJ45 Port

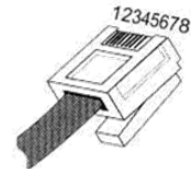

RJ45 Plug

Note: Other Pin must be NULL, if not may influence the of system.

communication

2.3 System Diagram

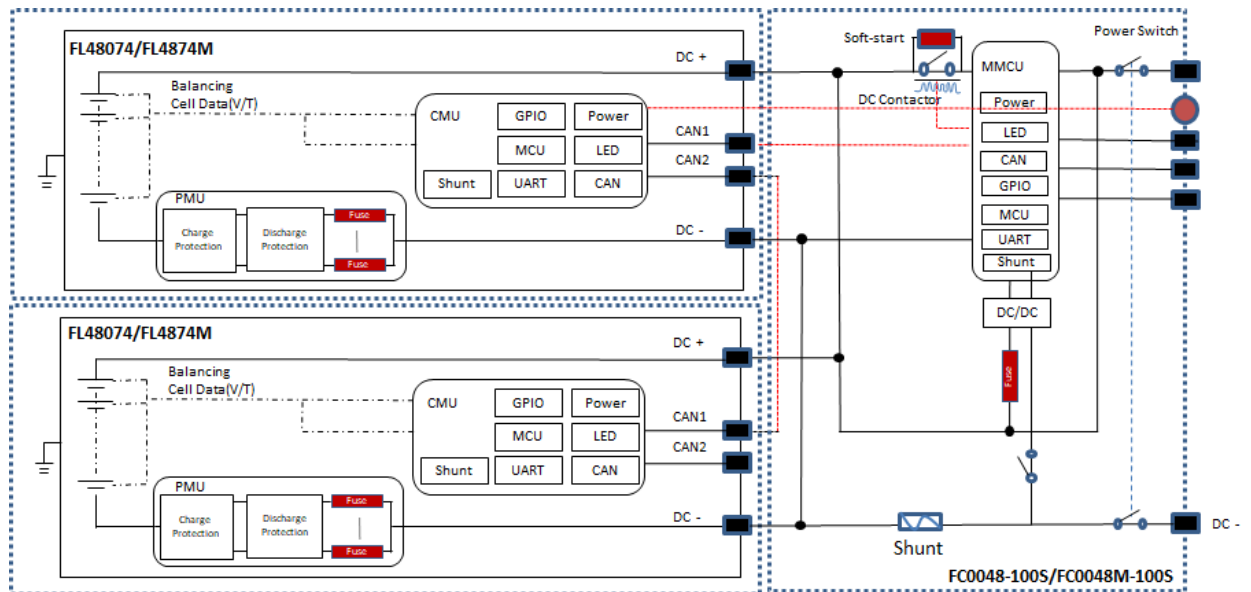

3. Installation

3.1 Tools

The following tools are required to install the battery pack:

 Wire Cutter	 Crimping Modular Plier	 Cable Ties
 Screw Driver Set	 Electric Screw Driver	 Multimeter
 Adjustable Wrench	 Sleeve Piece	

NOTE

Use properly insulated tools to prevent accidental electric shock or short circuits.

If insulated tools are not available, cover the entire exposed metal surfaces with available insulated alternatives, except their tips, with electrical tape.

3.2 Safety Gear

It is recommended to wear the following safety gear when dealing with the battery pack



Insulated gloves



Safety goggles



Safety shoes

3.3 System Working Environments Checking



3.3.1 Cleaning

Before installation and system power on, the dust and iron scurf must be removed to keep a clean environment.

The system cannot be installed in desert area without an enclosure to prevent from sand.



3.3.2 Temperature

Force-L2 system working temperature range: 0°C~50°C; Optimum temperature: 18°C~28°C.

Caution: Force-L2 system is out-door design. But please avoid frost or direct sunlight. Out of the working temperature range will cause the battery system over / low temperature alarm or protection which further lead to the cycle life reduction. According to the environment, the cooling system or heating system should be installed if it is necessary.



3.3.3 Fire-extinguisher System

It will be better equipped with fire-extinguisher system for safety purpose.

The fire system needs to be regularly checked to be in normal condition. Refer to the using and maintenance requirements please follow local fire equipment guidance.



3.3.4 Grounding System

Before the battery installation must make sure the grounding point of the basement is stable and reliable. If the battery system is installed in an independent equipment cabin (e.g. container), must make sure the grounding of the cabin is stable and reliable.

The resistance of the grounding system must $\leq 100m\Omega$



3.4 Handling and placement

Single battery module is 35kg. If without handling tools must have more than 2 men to handling with it.

3.4.1 Handling and placement of the base

The base is light, single person can handle with it.

3.4.2 Selection of installation sites

- A. Force-L2 system working temperature range: 0°C~50°C; Optimum temperature: 18°C~28°C.
Do not place the battery system in direct sun light. It is suggested to build sunshade equipment.
In could area the heating system is required.
- B. Force-L2 system must not be immersed in water. Cannot be placed the battery base in rain or other water sources. As a suggestion, the base's height should >300mm above the ground.
- C. The base's weight capacity should support the weight of whole battery system (119~260kg).

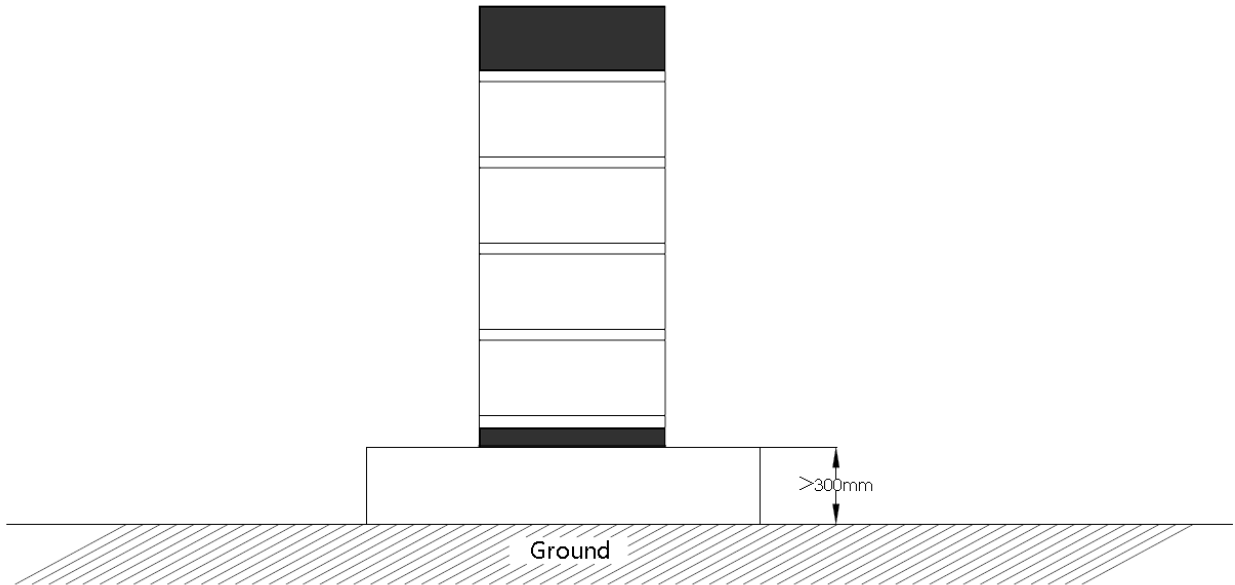
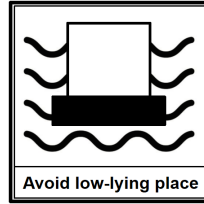
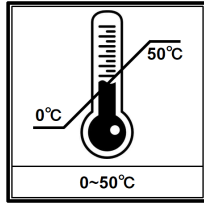
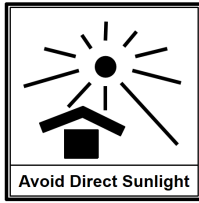

Packing List

FC0048M-100S Battery Controller		
Item	Description	Set
1	FC0048M-100S Battery Controller	1
2	Force-L2 basement (450*296*40, mm)	1
3	EPE foam	2
4	3.5M black external CAN communication cable (RJ45 – M19)	2
5	3.5M black external RS485 communication cable (RJ45 – M19)	
5	3.5M DC+ red external power cable (4AWG)	1
6	3.5M DC- black external power cable (4AWG)	1
7	2M yellow-green grounding cable (6AWG)	1
8	M4 screws for fixing brackets	12
9	M8 bolts for fixing basement	4
10	Product Manual	1
11	Warranty card	1
FL4874M Battery Module		
1	FL4874M battery module	1
2	EPE foam	2

External Bracket Kit*		
1	660 mm bracket For up to 2 battery modules installation	2
2	622 mm bracket In combine use with 660mm bracket for up to 4 modules installation; see below installation picture;	2

*The external bracket kit only needed when the product article number (can be checked on Battery controller carton box) is **FC0048MA02V00102**.

3.4.4 Mounting and installation of the base

The base must be fixed installed on the basement with 4pcs M8×80 foundation bolts.

Battery rack basement holes' bitmap (unit: mm):

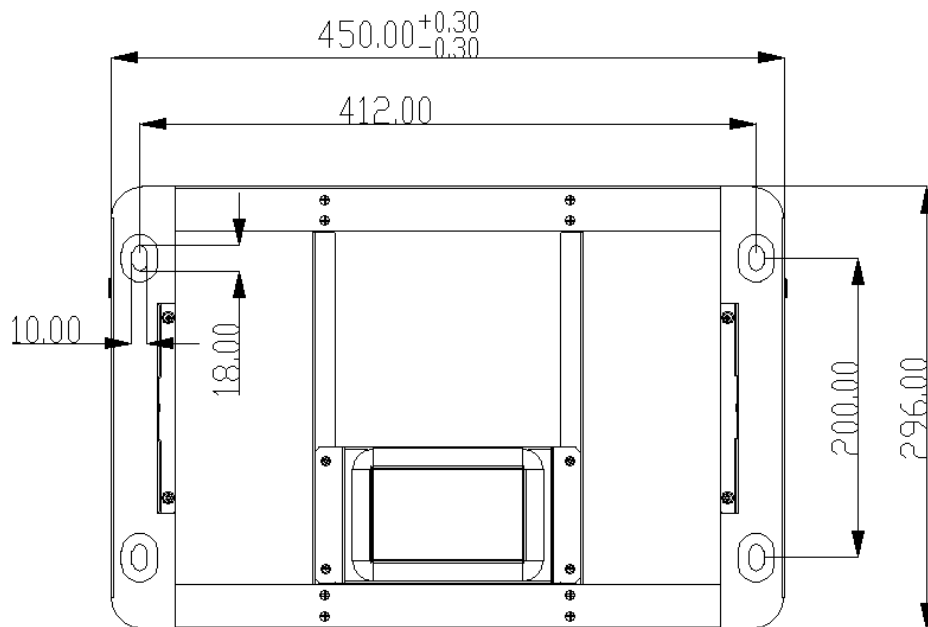

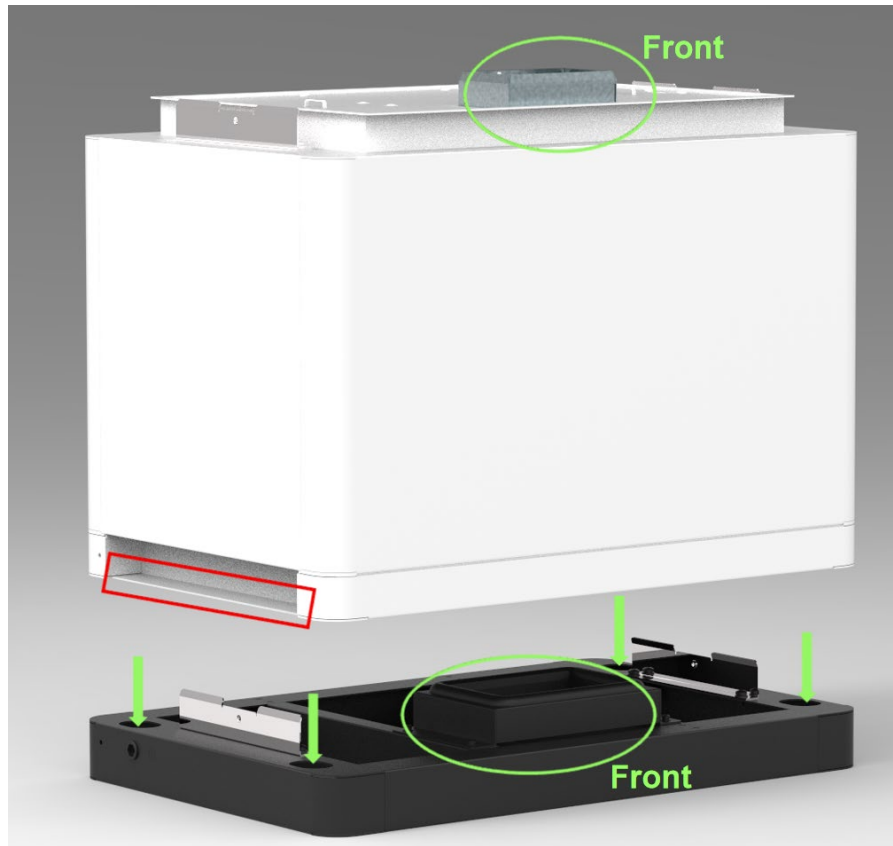

3.4.5 Battery Modules and Control Module (BMS) pile up

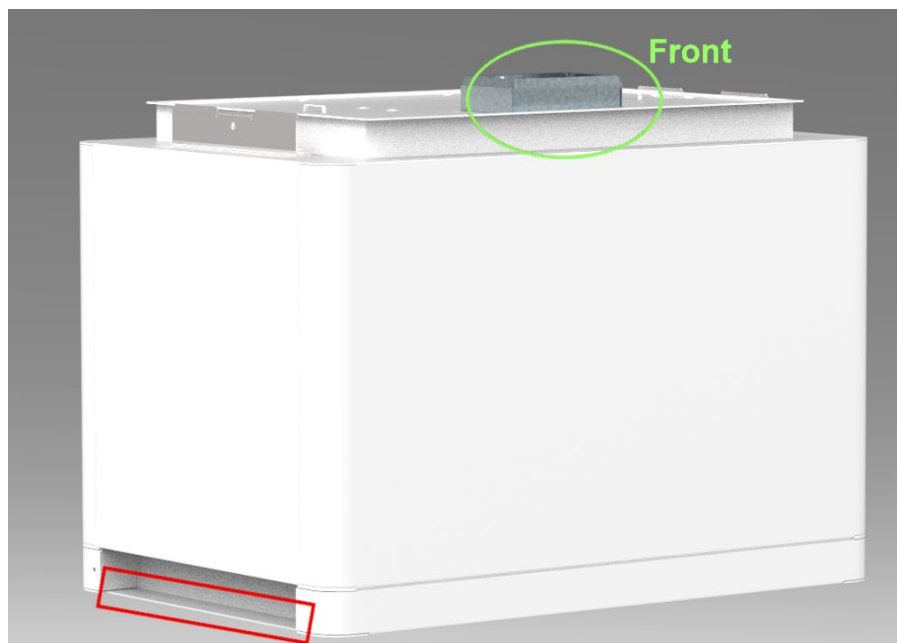

Handle above the red marked edgings of the both side of these battery modules and control module (BMS).

Caution: If hands under this red marked side, hands will get hurt.

3.4.6 Installation of the fixed metal bracket for the system

In control module's package, there are 2pcs Controller-2-modules-bracket, and 2pcs Base-2-modules-bracket.

Fix these metal brackets at the both back side corners.

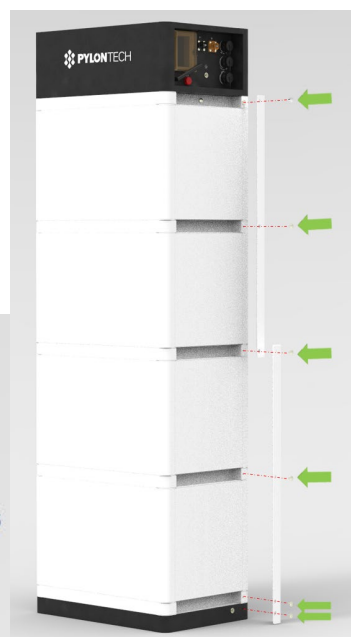
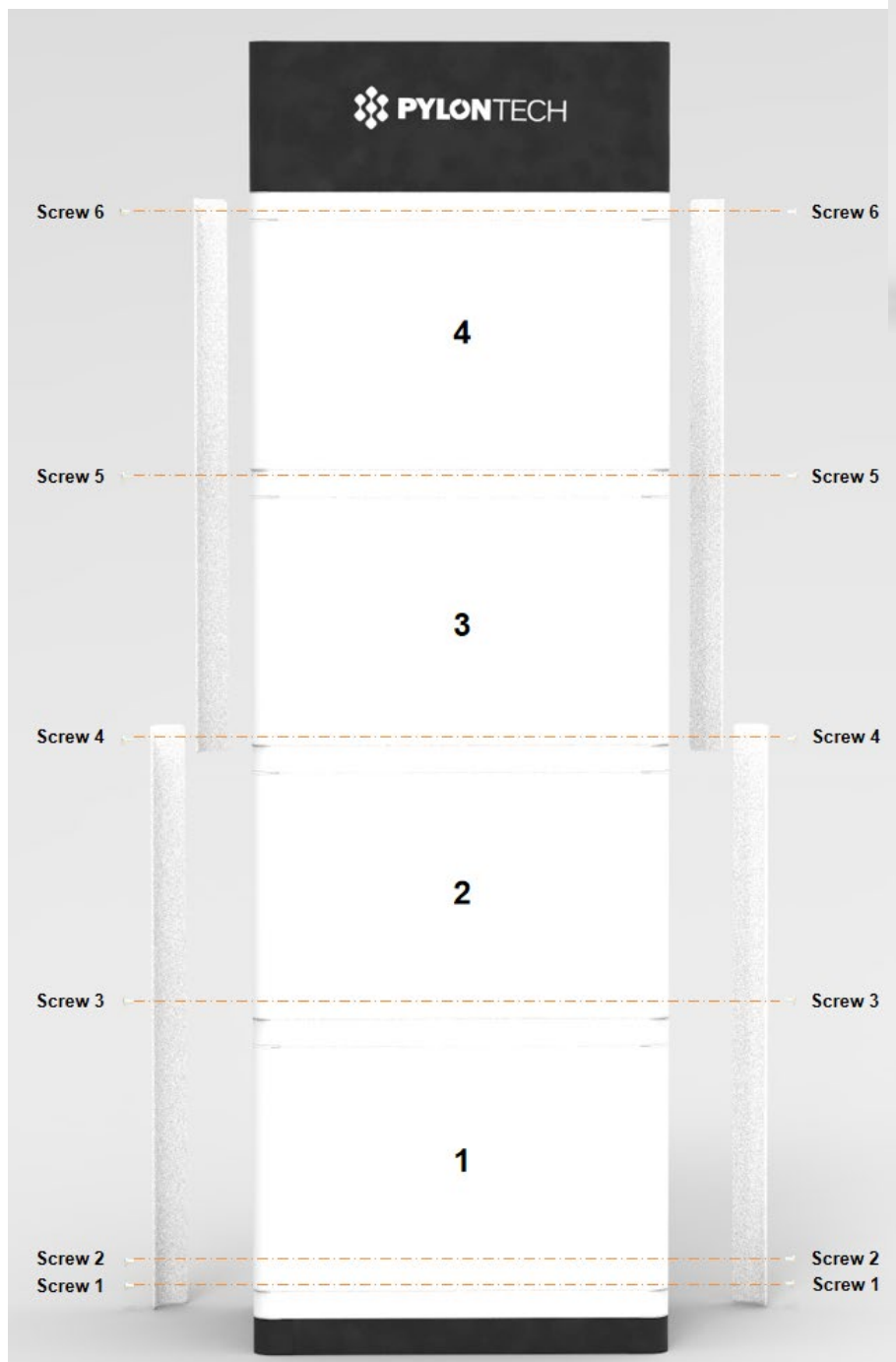



3.4.7 Locking of control module's fix screw of left and right side



And dismantle the Protection Cover of the Power Terminals.



3.5 Cables connection



- Connect the power Terminal +/- to the inverter or the DC switches.



Danger: All the plugs and sockets of the power cables must be not reverse connection.

Danger: Do not short circuit or reserved connection of the battery system's positive and negative port.



Caution: Wrong communication cables connection will cause the battery system failure.

- Connect the communication cables between battery stacks: one by one from **Stack last** to the **Stack 1** (from **LinkPort0** to **Linkport1**).
- Connect the communication cable between master battery stack (Stack 1) to the inverter.
- The length of communication cable between stacks must $\leq 2\text{m}$.
- It is recommended to use cable provided by Pylon, if not the compatible water proofed connecter (M19-RJ45) is necessary.

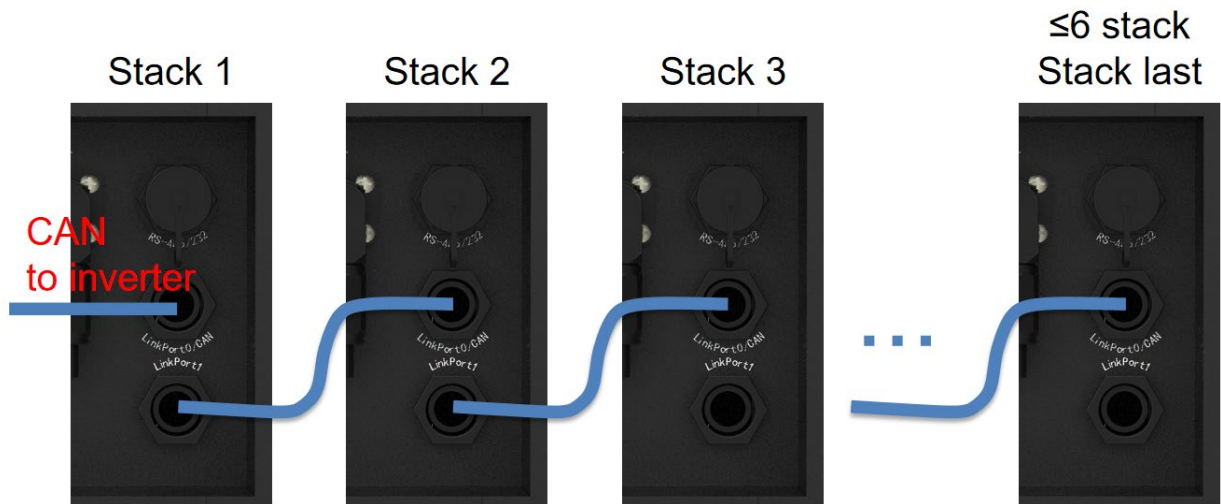

Or

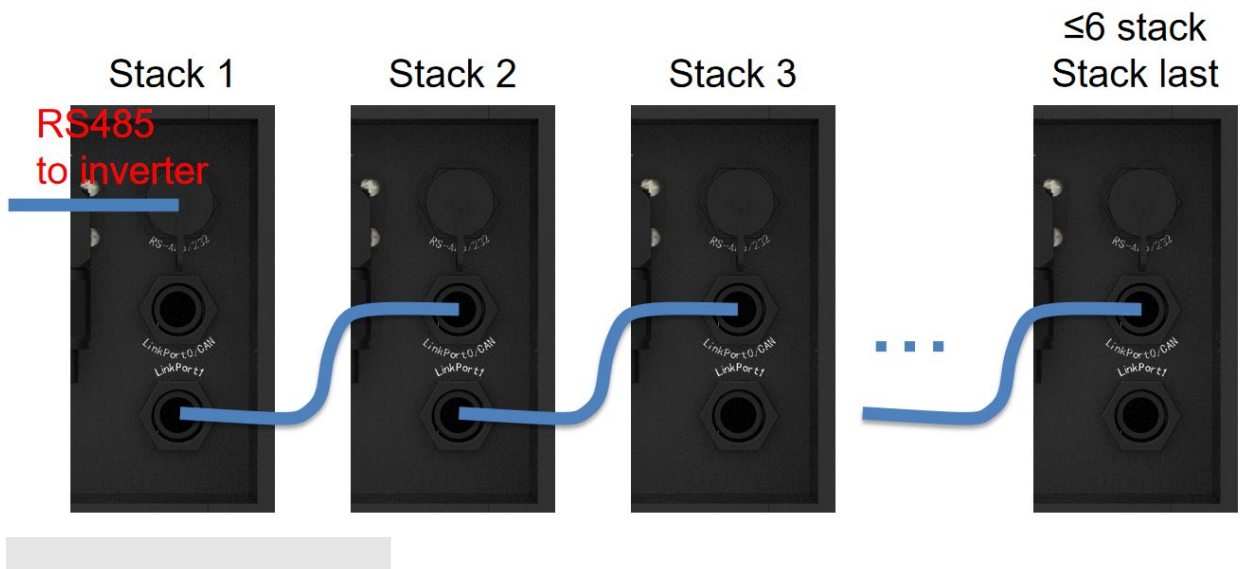



3.5.1 Grounding

The Force-L2 modules' grounding cable on the Cable Panel's grounding point.



Or the M6 grounding bolt on the frame base.

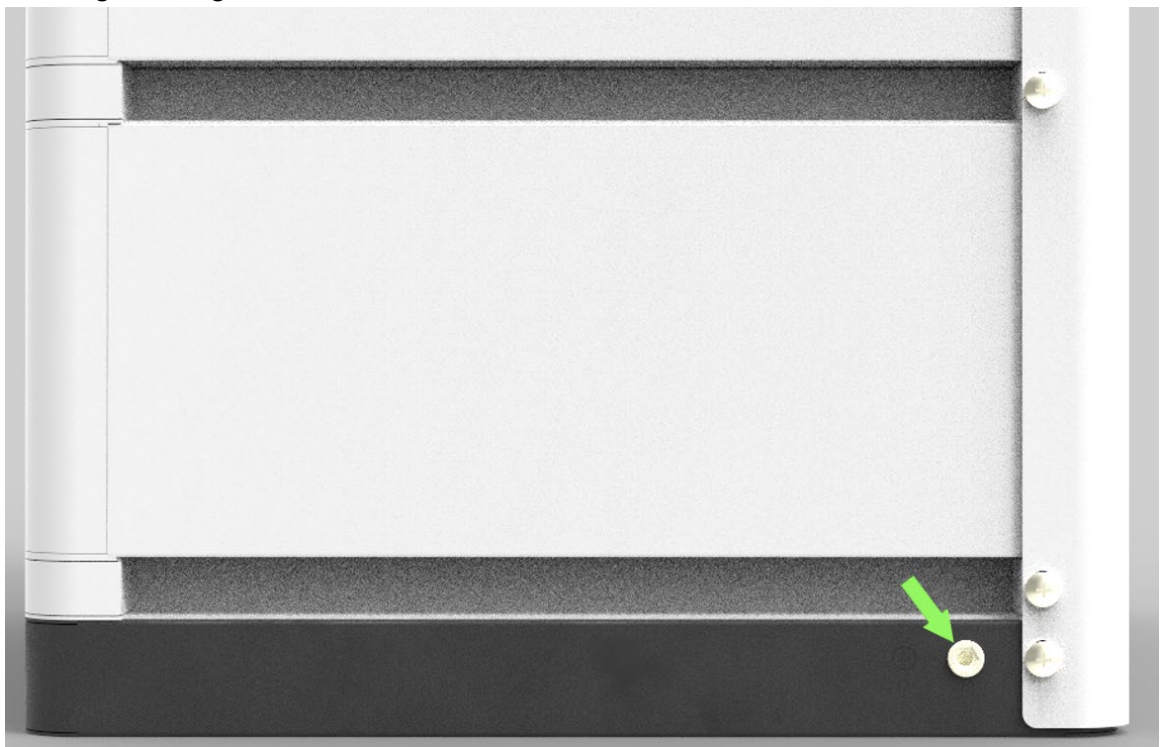

Grounding cable must **≥6AWG**. The cable shall be copper with yellow-green color.

3.5.2 Cables

Note: Power cable uses water-proofed connectors.

Note: Communication cable uses RJ45 connector and water-proofed cover matched with controller connection port.

For inverter follow same pin definition, the communication cable can be used directly.

For inverter with different pin definition or not using RJ45 port, when change the connector, please check the pin order and make sure undefined pin is **not** connected with each other and **not** connected to the inverter.

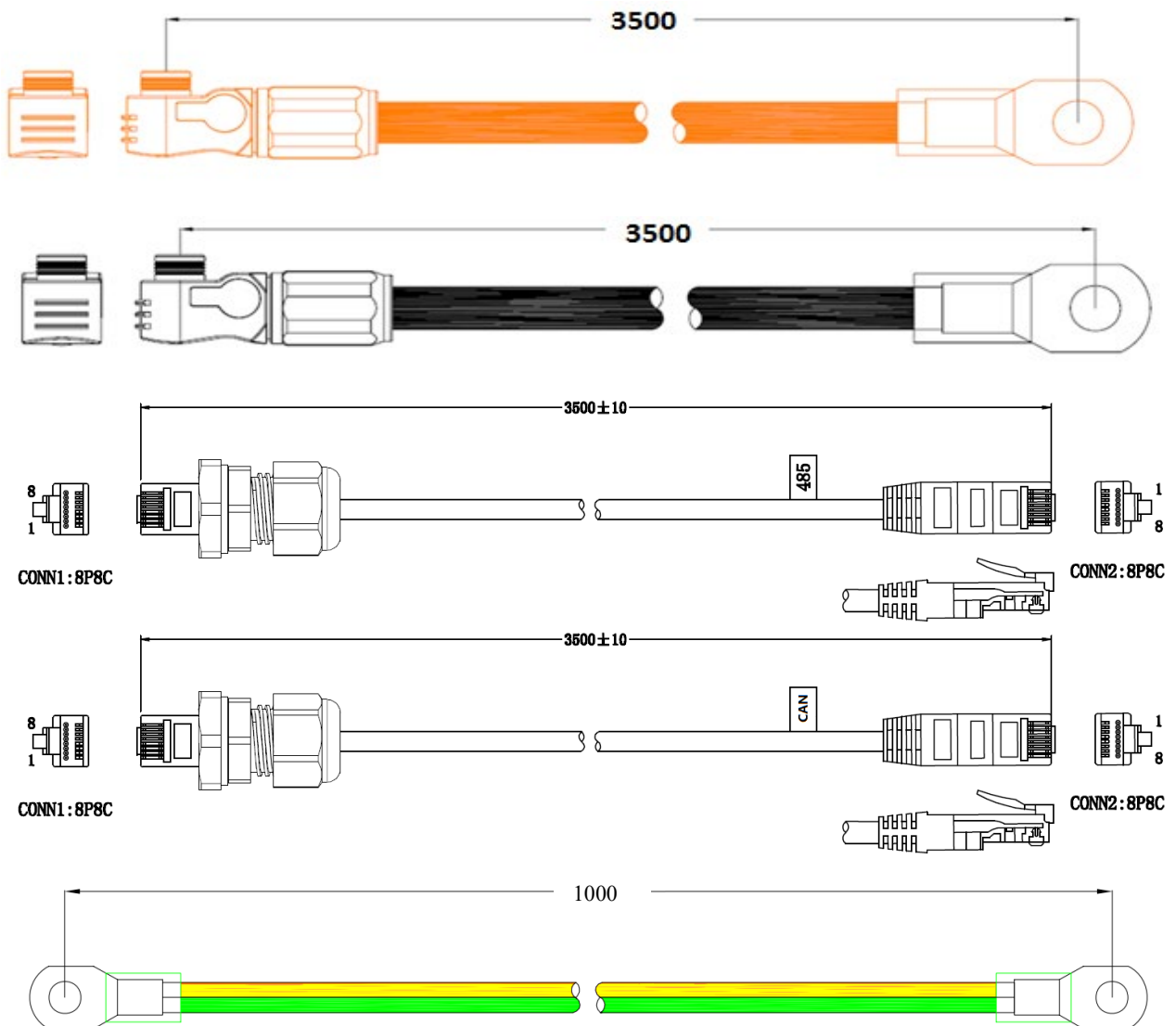

3.5.3 System turns on



Warning: Double check all the power cables and communication cables. Make sure the voltage of the inverter is same level with the battery system before connection. Check all the power switch of every battery system is OFF.

System turns on step:

- 1) Check all cables are connected rightly. Check grounding is connected.
- 2) Open protect cover of breaker and turn on Power Switch first then turn on BMS Switch.
If DC side has voltage higher than 48V, then BMS will wake up by inverter.
If DC side do not have voltage, then press start button for more than 5 seconds, and then wait.
It takes 10-30 seconds for BMS self-checking and wake up battery modules. Then the system is ready. You can touch the LED button and see how led flash.



Caution: When the breaker is tripped off because of over current or short circuit, please wait 30min before turns on again, otherwise may cause the breaker damage.



Warning: If has failure during the self-check, must debug the failure then can start next step.

If the "STATUS" lamp shows solid orange from beginning, it means there has some failure in the battery string, the Power Relays in BMS will open, must debug at first.

Note: The LED lamp will be off in 20sec without any operation.

Caution: it is suggested to fully charge the whole Battery Energy Storage System (BESS) first after installation or after long time storage without charging. Depending on the soc level, there will be a regularly (3 month) fully charge requesting during continuous operation as well, it will be handled automatically by the communication between BESS and external device.

After debug must install the Protection Cover of the Power Terminals back.

3.5.4 System turns off

When failure or before service, must turn the battery storage system off:

- 1) Turn off inverter or power supply on DC side.
- 2) Turn off BMS switch
- 3) Turn off power switch
- 4) Turn off switch between battery and inverter



Under emergency condition, it is suggested to turn off switch between battery system and inverter first.

NOTE

After installation, DO NOT forget to register online for full warranty:

www.pylontech.com.cn/service/support

4. System Debug

This system debug is for BESS system (Battery Energy Storage System). BESS system can't do the debug itself. It must operation with configured inverter, UPS and EMS system together.

Debug Step	Content
Prepare of debug.	<p>Turn on the BESS system, refer to chapter 3. The battery system will close relay and has power output.</p> <p>Remark: Except the BESS, if other equipment has its own system turn on step, must follow the operation manual.</p>
Working together with inverter.	<ol style="list-style-type: none">1) Check the communication cable connection and make sure the cable order on battery and inverter side are matched. All undefined pin should be empty.2) Check the baud rate of inverter. The default of battery CAN is 500kbps, 485 is 115200bps. If necessary, change the baud rate of RS485.3) Check the terminal resistance CAN 60 Ω, RS485 120Ω4) If necessary, check the setting on inverter or control box has right parameter and brand of battery. And check the information of BESS shown on inverter is correct.

5. Maintenance

5.1 Trouble Shooting:

Check the environment first,

No	Problem	Possible Reason	Solution
1	No power output, no led on.	Press start button too short.	Press at least longer than 2 seconds.
		The button battery in controller is missing or failure. The power supply in controller is failure.	Change the controller module
		The battery voltage is too low.	Change the first battery module.
2	All 7 batteries led flash orange.	Address distribution failure.	Change the controller. Or remove the battery module one by one and restart, until works. Then the last removed one is failure.
3	Single battery led light on orange	Battery module failure or under protection. Cell or module voltage or temperature too low or too high.	Charge the system by inverter or charger (53.5V, \leq 10A), if turns normal, then it works. If not, replace the battery module.
4	Single battery led slow flash orange	Battery module offline	Charge the system by inverter or charger (53.5Vdc, \leq 10Amps), if turns normal, then it works. If not, replace the battery module.
5	Single battery led flash blue	Alarm.	Ignore, and the system can work
6	Status led light on orange.	Error on controller module.	Restart or replace controller.
		Cell or module or controller under protection.	Check battery led and debug. Press start button for 10 seconds, if has power output then charge the system. If not, using debug tool for further check.
		Other failure.	Replace the controller.
7	Status led slow flash orange	Voltage or temperature too low or too high.	- Temperature abnormal: Put battery system under normal

			<p>environment and wait until protection release.</p> <p>-Temperature normal: make sure no power cable connected, try black start operation.</p> <p>If works, monitor the voltage at dc terminal, if too low then turn off and charge the system.</p> <p>If do not response the black start, use debug tool for further check.</p>
		Under current protection.	Check no short circuit or big capacitor or load at DC side, before turning on the system

Once a certain failure detected following the trouble shooting steps, shut down the battery string first before replacement to avoid further over discharge to the system due to the self-consumption.

5.2 Replacement of main component

Caution: Before replace the main component must shut down the maintenance battery string's power. The shutdown progress refers to chapter 3.6.5.

5.2.1 Replacement of Battery Module

5.2.1.1 Use a charger(53.5Vdc, ≤ 10 Amps) to charge the new battery module and existing module to full (SOC 100%)

5.2.1.2 Turn off the whole battery string's power. Must confirm the **D+** and **D-** terminal are without power. The turn off progress refer to chapter 3.6.5.

Dismantle the Protection Cover of the Power Terminals.



5.2.1.3 Dismantle **D+** and **D-** Power Cable, Communication Cable and Grounding Cable if necessary.

5.2.1.4 Dismantle the control Module's fix screw of left and right side. And dismantle the fix metal brackets.

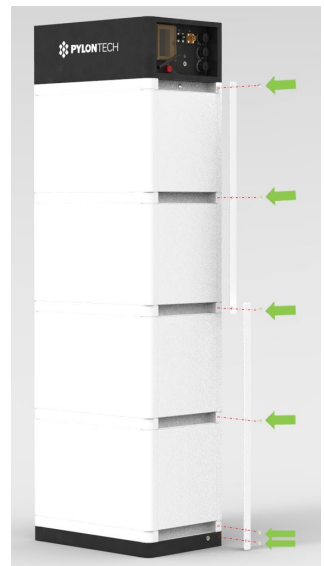

5.2.1.5 Move the control module and each battery module one by one.

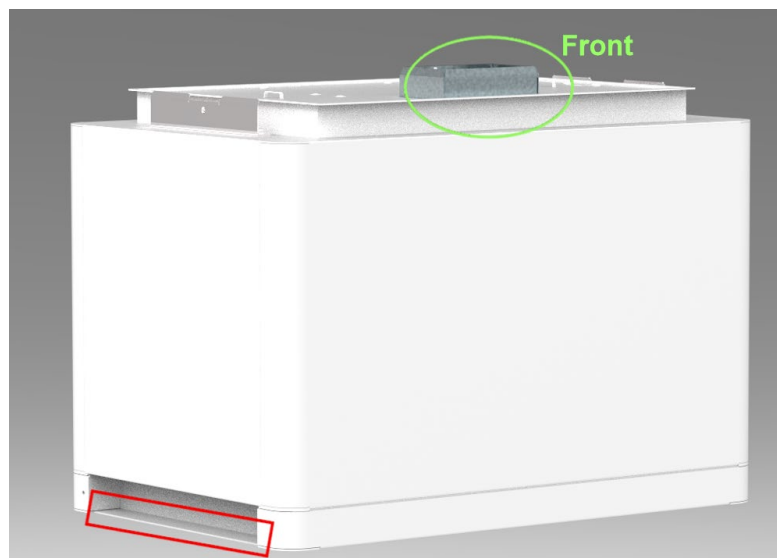

Handle above the red marked edgings of the both side of these battery modules and control module (BMS).

Caution: If hands under this red marked side, hands will get hurt.



Warning: Single battery module is 35kg. If without handling tools must more than 2 men to handling with it.



Caution: Before replace the battery module for service, must charge/discharge the replaced battery to the same voltage of other battery modules in system. Otherwise the system needs long time to do the balance for this new battery module.

5.2.1.6 Pile up the new battery module. And pile up the battery modules and control module up again.

5.2.1.7 Install back the control Module's fix screw of left and right side. And Install back the fixed metal brackets.

5.2.1.8 Install back Grounding Cable, Communication Cable and the **D+** and **D-** Power Cable.

5.2.1.9 Turn on this battery string. Refer to chapter 3.6.

5.2.1.10 After debug must install the Protection Cover of the Power Terminals back.

5.2.2 Replacement of Control Module (BMS)

5.2.2.1 Turn off the whole battery string's power. Must confirm the **D+** and **D-** terminal are without power. The turn off progress refer to chapter 3.6.5.

5.2.2.2 Dismantle the Protection Cover of the Power Terminals. Dismantle **D+** and **D-** Power Cable, Communication Cable and Grounding Cable.



5.2.2.3 Dismantle the control Module's fix screw of left and right side. And dismantle the fixed metal brackets.

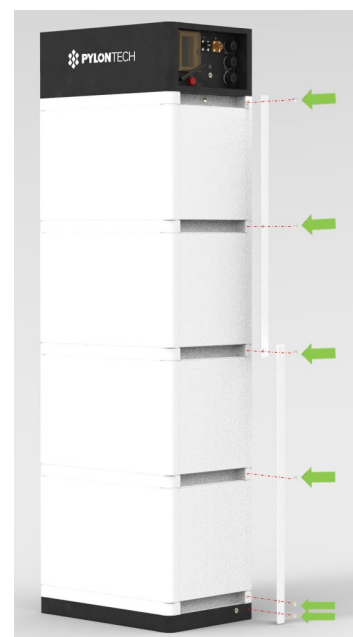

5.2.2.4 Remove the control module.

5.2.2.5 Pile up the new control module.

5.2.2.6 Install back the control Module's fix screw of left and right side. And Install back the fixed metal brackets.

5.2.2.7 Install back Grounding Cable, Communication Cable and the **D+** and **D-** Power Cable.

5.2.2.8 Turn on this battery string. Refer to chapter 3.6.

5.2.2.9 After debug must install the Protection Cover of the Power Terminals back.



5.3 Battery Maintenance

5.3.1 Voltage Inspection:

[Periodical Maintenance] Check the voltage of battery system through the monitor system. Check the system abnormal voltage or not. For example: Single cell's voltage is abnormal high or low.

5.3.2 SOC Inspection:

[Periodical Maintenance] Check the SOC of battery system through the monitor system. Check the battery string abnormal SOC or not.

5.3.3 Cables Inspection:

[Periodical Maintenance] Visual inspect all the cables of battery system. Check the cables has broken, aging, getting loose or not.

5.3.4 Balancing:

[Periodical Maintenance] The battery strings will become unbalance if long time not full charged. Solution: every 3 months should do the balancing maintenance (charge to full), normally it will be done automatically by the communication between system and external device.

5.3.5 Output Relay Inspection:

[Periodical Maintenance] Under low load condition (low current), control the output relay OFF and ON to hear the relay has click voice, that's mean this relay can off and on normally.

5.3.6 History Inspection:

[Periodical Maintenance] Analysis the history record to check has accident (alarm and protection) or not, and analysis its reason.

5.3.7 Shutdown and Maintenance:

[Periodical Maintenance]

Some system function must be maintenance during the EMS restart, it is recommended to maintenance the system every 6 months.

5.3.8 Recycle

NOTE

Damaged batteries may leak electrolyte or produce flammable gas.

In case a damaged battery needs recycling, it shall follow the local recycling regulation (e.g. Regulation (EC) N° 1013/2006 among European Union) to process, and using the best available techniques to achieve a relevant recycling efficiency.

6. Storage Recommendations

b) For long-term storage (more than 6 months), the battery cells should be stored in the temperature range of 5~45°C, relative humidity <65% and contains no corrosive gas environment.

The battery module should be shelved in range of 5~45°C, dry, clean and well ventilated environment. Before storage the battery should be charged to 50~55% SOC;

It is recommended to activate the chemical (discharge and charge) of the battery every 6 months, and the longest discharge and charge interval shall not exceed 12 months.



Caution: If not follow the above instructions for long term store the battery, the cycle life will have heavily reduction.

7. Shipment

Battery module will pre-charged to 60~70% SOC or according to customer requirement before shipment. The remaining capacity of battery cell, after shipment and before charge, is determined by the storage time and condition.

1. The battery modules meet the UN38.3 certificate standard.
2. In particular, special rules for the carriage of goods on the road and the current dangerous goods law, specifically ADR (European Convention on the International Carriage of Dangerous Goods by Road), as amended, must be observed.

Any further questions, please contact Pylontech: service@pylontech.com.cn



PYLONTECH

Pylon Technologies Co., Ltd.

5/F, No.71-72, Lane 887, ZuChongzhi Road, China (Shanghai) Pilot Free Trade Zone

Pudong, Shanghai 201203, China

T+86-21-51317699 | **F** +86-21-51317698

E service@pylontech.com.cn

W www.pylontech.com.cn